

LAGO

TIMELESS DESIGN FOR CONTEMPORARY LIVING

ITALIANO · ENGLISH

LAGO.IT /   LAGODESIGN

BULLETIN 2017 · 2018

LAGO

“La persona rimessa al centro del tutto.
Questo è il modo in cui intendiamo il design”.

Ideare e realizzare arredi che definiscano interni di qualità ci ha insegnato cosa può significare “sentirsi a casa”. Nel tempo, abbiamo imparato a progettare ogni spazio su misura, dando importanza a ciascun dettaglio per rispondere a specifiche esigenze e avverare i desideri di ognuno, con l’obiettivo, semplice e ambizioso allo stesso tempo, di definire luoghi da abitare dove vivere bene in ogni momento della giornata.

Per questo, progettiamo partendo dall’ascolto di chi ci sceglie. Molti anni fa abbiamo ideato un mattoncino del design, arrivando a consegnare alle persone un alfabeto di arredi modulari e leggeri, con cui costruire uno sguardo d’insieme, fatto di spazi, esperienze e connessioni declinati nella casa intera: - soggiorno - cucina - camera da letto - camerette dei bambini - bagno.

In queste pagine troverai i progetti di chi ci ha scelto, varcando la soglia di case diverse tra loro, tra storie fatte di spazi piccoli e grandi interpretati in modo unico da un design sartoriale, distintivo, fortemente empatico. Con questo LAGO BULLETIN ti porteremo a scoprire gli ingredienti della nostra gamma completa di arredi, per lasciarti ispirare e poter creare una casa dalla personalità unica: la tua.

Daniele Lago

‘Putting the individual back in the centre.
That is how we understand design.’

Designing and producing furnishings that define fine interiors has taught us what it means to ‘feel at home’. Over time, we have learned to tailor our design to every unique space, placing importance on each and every detail in order to meet specific needs and satisfy everyone’s desires, with the goal, at once both simple and ambitious, of creating living spaces where you can live well every minute of the day.

This is why when we design we start by listening to the people who choose us. Years ago, we created a design building block, arriving at offering people an alphabet of modular, airy furniture for creating an overall look made up of space, experiences and connections expressed throughout the entire home: - living room - kitchen - bedroom - children’s rooms - bathroom.

In these pages, you will find the interior design projects of people who chose LAGO, crossing the threshold of a range of different of homes, encountering stories made up of spaces big and small interpreted in a unique way by our sartorial, distinctive, powerfully empathetic design. In this LAGO BULLETIN, we will lead you through the discovery of the ingredients of our complete range of furniture, filling you with inspiration and preparing you to create a home with a unique personality: yours.

Daniele Lago

LAGO FABBRICA

SOSTENIBILITÀ UMANA E INNOVAZIONE · HUMAN SUSTAINABILITY AND INNOVATION

INTERIOR LIFE MANIFESTO.

- #1** Immediati e semplici.
- #2** Progettiamo interni per la tua vita interiore.
- #3** Crediamo nelle relazioni umane - atomi e bit.
- #4** Abbiamo una bussola - Cervello Cuore Coraggio.
- #5** Pensiamo il pieno per far vivere il vuoto.
- #6** _____
- #7** La bellezza è nella visione d'insieme.
- #8** L'essenziale per durare nel tempo.
- #9** Il design sei tu, noi forniamo l'alfabeto.
- #10** La creatività arriva quando fai ciò che ami.
- #11** Mai fermi.
-
- #1** Immediate and simple.
- #2** We design interiors for your interior life.
- #3** We believe in the atoms and bits of human relationships.
- #4** We have a compass—Head Heart Courage.
- #5** We plan the solid to breathe life into the void.
- #6** _____
- #7** Beauty lies in the vision of the whole.
- #8** The essentials, for enduring over time.
- #9** You are the design; we provide the alphabet.
- #10** Creativity comes when you do what you love.
- #11** Never stop.



#LIGHT #GREEN #SUNSETS #WOOD #HOME #LEANPRODUCTION

La LAGO FABBRICA nasce per essere una “non fabbrica” di 11.000 mq: una grande casa per una famiglia di centinaia di persone, costruita secondo i principi della bioarchitettura. Portatrice di un Lean Thinking utile a produrre un design sostenibile e personalizzabile, la LAGO FABBRICA pulsa di energia: permeata dalla luce dei tramonti che attraversano le pareti perimetrali trasparenti, restituisce vitalità autentica, perché l'uomo che produce è anche l'uomo che consuma.

The LAGO FABBRICA was designed to be an 11,000 square-metre ‘not-factory’: a huge house for a family of hundreds, built following the principles of bio-architecture. Using Lean Thinking to help produce sustainable, customisable design, the LAGO FABBRICA pulses with energy. Permeated by the light from the sunsets that come in through its transparent exterior walls, the space is filled with authentic vitality, since the person who produces is also the person who consumes.

INTERIOR SARTORIALE TAILORED INTERIOR

UNA GAMMA COMPLETA E VERSATILE · A COMPLETE, VERSATILE RANGE



Non ci nutriamo solamente di cibo ma assimiliamo e siamo parte anche di quello che vediamo e che ci sta intorno: con questa importante consapevolezza, grazie a una gamma completa e versatile riusciamo a cucire addosso alle persone spazi completi in grado di entrare in risonanza con loro. Da tutte le aree della casa, per arrivare a ristoranti, alberghi, spazi commerciali e lavorativi, la persona è sempre l'epicentro del progetto, il design strumento in grado di ascoltare e migliorare i nostri luoghi.

We are not nourished by food alone, but assimilate and are even part of what we see and find around us. With this important insight, thanks to a complete, versatile product line, we tailor spaces to the people who use them, creating interiors that enter into resonance with individuals. From all the areas of the home to restaurants, hotels, commercial spaces and offices, the individual is always the epicentre of the design, and design is a tool that listens to and improves the places of our lives.

DESIGN SENZA TEMPO TIMELESS DESIGN

LA SEMPLICITÀ DIALOGA CON OGNI STILE · SIMPLICITY IN DIALOGUE WITH ALL STYLES



Il design LAGO affonda la sua forza nella semplicità, caratterizzato da sospensioni leggere, modularità e mimesi architettonica, sprigionando un'innata capacità di dialogo con stili e contesti diversi. Prodotti raffinati e allo stesso tempo semplici si prestano a infinite declinazioni, risultando adattabili al variare degli ambienti e al mutare delle mode.

The strength of LAGO design is simplicity. Characterised by suspension, modularity and architectural mimesis, it has an innate capacity for entering into dialogue with different styles and contexts. Products simultaneously both refined and simple, lending themselves easily to infinite expressions and adapting to changing spaces and trends.

IL NOSTRO ALFABETO, LA TUA CASA

OUR ALPHABET, YOUR HOME



Con LAGO puoi progettare soluzioni di arredo per ogni stile, sogno e metratura: un alfabeto di arredi modulari che permette di progettare con personalità tutte le aree della casa. Piccolo o grande, ogni ambiente della tua casa si veste come vuoi tu.

With LAGO, you can design interiors to suit any style, dream and metrage, using an alphabet of modular furnishings that lets you infuse every room of the house with personality. Big or small, design every room of your house just the way you like it.



WWW.LAGO.IT/EN/WHOLEHOUSE



LARGE
SIZE
200m²

VOLUMI SO- SPESI SUL MARE

**VOLUMES SUSPENDED OVER
THE SEA**

**SUGGESTIVE TRASPARENZE PER UNA VILLA
CONTEMPORANEA IN COSTA BRAVA**

Una casa stagliata sulla costa, costruita su volumi a sbalzo con vetrate a tutta altezza, collega l'incontaminata natura esterna agli interni, ampi e luminosi. La famiglia che abita la villa voleva godere appieno della vista mozzafiato sul mare da qualsiasi stanza: il progetto di interior LAGO gioca con il ritmo di pieni e vuoti, utilizzando arredi sospesi su trasparenti lastre in vetro ed esaltando così da qualsiasi punto la privilegiata vista sul Mediterraneo. Gli interni degli ampi ambienti open space sono stati progettati riprendendo le nuance della baia ed enfatizzando la luminosità naturale, curando ogni dettaglio all'insegna dell'eleganza e del comfort.

EVOCATIVE TRANSPARENCIES: A CONTEMPORARY VILLA ON THE COSTA BRAVA

A house right on the coast, made up of projecting volumes and full-height windows, creating a link between the pristine nature outside and the spacious, light-filled interiors. The family who lives in the villa wanted to be able to fully enjoy the breathtaking view of the sea from every room, and LAGO's project for the interior made this dream reality by playing with the rhythm of solids and voids, using furniture suspended on transparent glass legs to enhance the stunning view of the Mediterranean from all vantage points. The interiors of the spacious open-plan rooms were designed to echo the nuances of the bay and make the most of the natural light, ensuring that every detail is about elegance and comfort.



LUCE NATURALE

Geometrie essenziali dall'estetica moderna e rispettosa del paesaggio definiscono i volumi esterni, che seguono naturalmente il declivio della costiera. All'interno, la zona giorno è immersa nella presenza costante della luce naturale, filo conduttore che permea l'intera abitazione. Il progetto d'interior unisce sala da pranzo e living, che diventano un ambiente unico dallo splendido affaccio sul mare, giocato sulle luminose tonalità del bianco. Il posto perfetto per riunire la famiglia, mantenendo un costante rapporto con il panorama esterno grazie a una leggerezza di forme aeree e contemporanee.

NATURAL LIGHT

The exterior volumes are marked by essential shapes with a modern aesthetic and respect for the landscape, naturally following the slope of the coast. Inside, the living room and dining room are flooded with natural light over the whole arc of the day, a feature shared with all of the other rooms in the house. The plan for the interior joins the dining room and living room to create a single space with a splendid view of the sea, playing on suspended furnishings and luminous white tones. It is the perfect place for gatherings, maintaining a constant relationship with the outside view.

Air Table p.74 + Steps Chair & Stool p.102 + Air Sofa p.41 + Air Shelf p.50



GLI ARREDI SOSPESI NELLA
ZONA LIVING LASCIANO
FILTRARE LA LUCE NATURALE

THE SUSPENDED
FURNISHINGS IN THE LIVING
ROOM LET THE NATURAL
LIGHT FILTER THROUGH



Air Table p.74 + Net Storage p.69

TRASPARENZE DA VIVERE

Da qualsiasi punto della casa la vista è sublime. La camera da letto è un'oasi di pace affacciata sul mare, intima e accogliente, capace di esaltare la vista a tutta altezza grazie al letto e ai comodini sospesi LAGO. Con un panorama così, anche il tempo dedicato al lavoro e allo studio scorre leggero: delimitato da una libreria che gioca con l'alternanza di cubi pieni e vuoti, lo spazio è un continuum tra interno ed esterno.

EXPERIENCE THE TRANSPARENCY

The view is sublime from every room in the house. The bedroom is an oasis of peace looking out over the sea, an intimate, welcoming space where the view is enhanced from floor to ceiling thanks to the suspended LAGO bed and bedside tables. With a view like this, even work and study are easier to bear, in a space that creates a continuum between interior and exterior marked out by shelving that plays with the alternation of solids and voids.



Fluttua Bed p.117

LA CAMERA DA LETTO È UNA
ROMANTICA FINESTRA SUL MARE,
SOSPESA E LEGGERA

THE SUSPENDED, AIRY BEDROOM
IS A ROMANTIC WINDOW
ONTO THE SEA

MEDIUM
SIZE
120m²

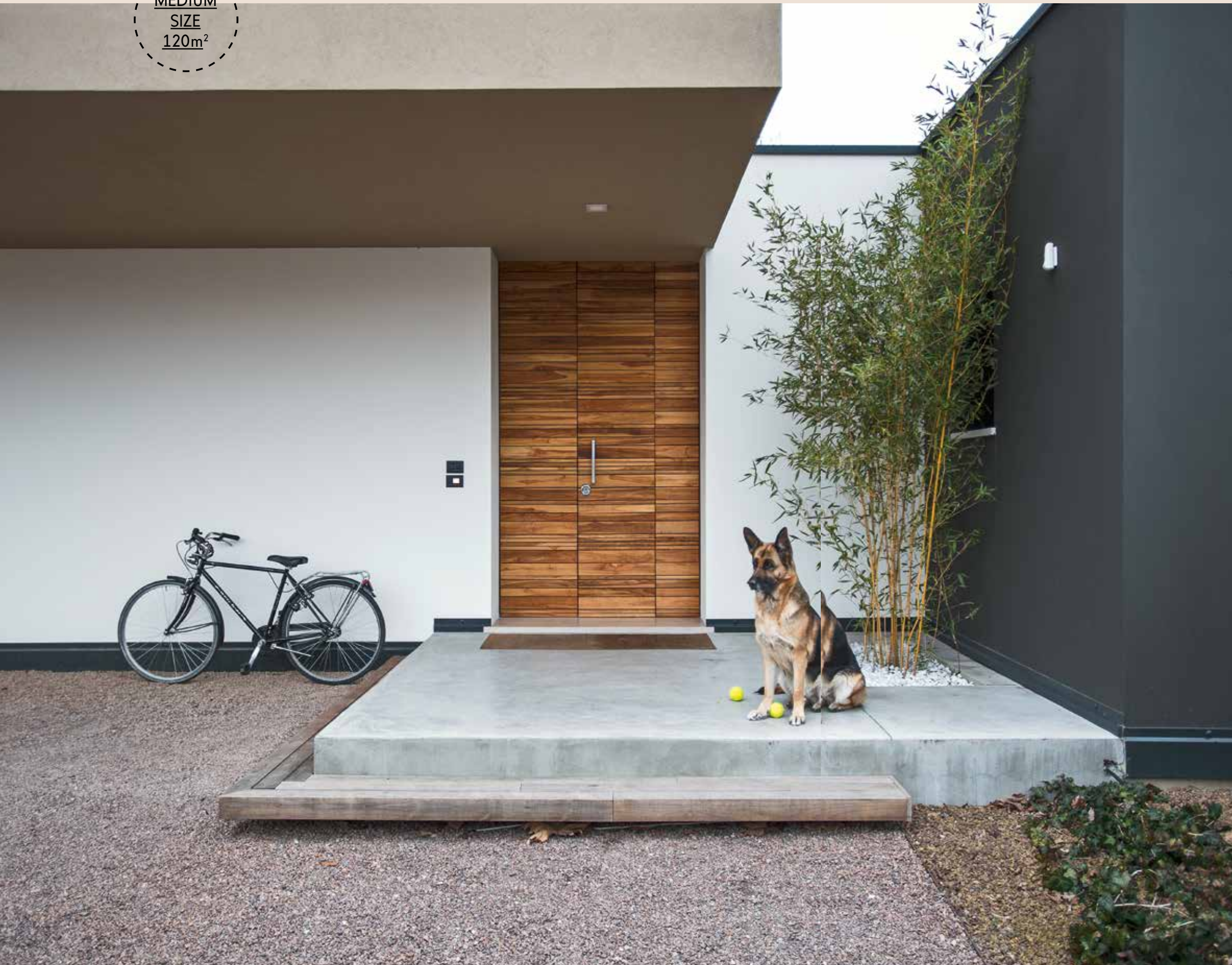

CLASSICO CONTEMPO- RANEO

CLASSIC CONTEMPORARY

UNA VILLA MODERNA PROGETTATA CON UN LINGUAGGIO SOBRIO E DINAMICO

“Vivere in un ambiente che ti sei progettato ti aiuta a stare bene, a tua volta generi un buon riflesso di te stesso e ti relazioni meglio con gli altri.” Margherita, che per lavoro progetta abitazioni a basso consumo, aveva un’idea chiara su come volesse la propria casa, da vivere con il marito Stefano e il figlio Alessandro: un ambiente al tempo stesso moderno, elegante e confortevole, in grado di rispecchiare con naturalezza le loro personalità e il loro modo di vivere. L’interior, reso arioso da arredi sospesi, con volumi che si incontrano a sbalzo o su appoggi leggeri, risponde alle esigenze di relax e condivisione, all’insegna di una socialità informale e in continuo dialogo con l’esterno.

A MODERN VILLA DESIGNED WITH A SIMPLE, DYNAMIC LANGUAGE

‘Living in a space that you designed yourself is good for the soul, it creates a good reflection of you and helps you to relate better with others.’ Margherita, who plans low-energy homes, had a clear idea for the design of her own home, to be shared with her husband Stefano and son Alessandro: a modern, elegant, comfortable space that natural reflects their personality and way of life. The interior, with an airy atmosphere created by suspended furnishings and volumes that overhang or rest lightly on one another, meets the family’s needs for relaxation and sharing, oriented towards casual socialising and in continuous dialogue with the outdoors.

LIVING E CUCINA SONO UN AMPIO
OPEN SPACE CHE CONDIVIDE LO
STESSO LINGUAGGIO

THE LIVING ROOM AND KITCHEN
SHARE AN OPEN-SPACE PLAN AND
THE SAME DESIGN LANGUAGE

Air Sofa p.41 + LagoLinea Shelf p.56 + Air Table p.74



36e8® Kitchen p.88

LA PENISOLA SOSPESA SU VETRO
TRASPARENTE ALLEGGERISCE I VOLUMI
E RESTITUISCE LUMINOSITÀ

SUSPENDING THE PENINSULA ON
TRANSPARENT GLASS LIGHTENS UP
THE VOLUMES AND ADDS LUMINOSITY



36e8® Kitchen p.88

CUCINA SU MISURA

Il sogno di Margherita era avere una cucina che le permettesse di condividere il rituale del cucinare con la famiglia e gli ospiti, in totale libertà. La cucina LAGO, sospesa e con volumi a sbalzo, permette un dialogo con il living ed è altamente funzionale: volumi dinamici creano spazi di appoggio e l'assenza di zoccoli facilita la fruizione.

Stefano e Margherita volevano una zona giorno open space libera da volumi ingombranti: il progettista ha previsto una penisola sospesa che restituisce luminosità e continuità con lo spazio esterno. Attorno, tutto scorre liberamente.

TAILORED KITCHEN

Margherita's dream was to have a kitchen that lets her share the ritual of cooking with family and friends, in total freedom. The suspended LAGO kitchen, with projecting volumes, creates a dialogue with the living room and encourages use: dynamic volumes create practical and inviting horizontal surfaces and the absence of skirting facilitates use.

Stefano and Margherita wanted an open-space plan and airy volumes for the kitchen and living room, so the designer opted for a suspended peninsula kitchen that adds luminosity and creates continuity with the outside space. All around, everything flows freely through the space.



Huggy Armchair p.69



IN CAMERA, IL LETTO
ESPRIME LEGGEREZZA,
SOSPENSIONE E SORPRESA

IN THE BEDROOM, THE
BED EXPRESSES LIGHTNESS,
SUSPENSION AND SURPRISE

Air Bed p.120

La continuità di linguaggio della zona notte mantiene una forte identità con i colori della natura circostante e lascia filtrare la luce senza ostacoli. Il letto sospeso su gambe in vetro extrachiaro e il lavandino che sembra staccarsi dal muro portano sorpresa e un tocco di romanticismo moderno, proprio come piace a Margherita.

In the bedrooms, the colour palette draws on the natural setting and light filters in unobstructed. In Alessandro's room, the armchair can transform into an extra bed for sleepovers. In the main bedroom, the bed, suspended on transparent glass legs, adds an element of surprise and a touch of modern romanticism to the space, perfectly suited to Margherita's style.



Skin Basin p.140

36e8® Kitchen p.88 + Air Sofa p.41 + 36e8® Storage p.33 + Lagolinea p.56 + Air Table p.74 + Dangla Chair p.84

SMALL
SIZE
53m²

IL MINI SOP- PALCATO

MINI FLAT WITH A LOFT

ANCHE LO SPAZIO PIÙ PICCOLO SI ESPRIME CON PERSONALITÀ

Un mini appartamento nel centro di Milano diventa un piccolo gioiello di design, progettato con un linguaggio unico che impreziosisce ogni dettaglio. L'open space soppalcato è il rifugio di una giovane coppia che non voleva rinunciare ad estetica e funzionalità in metrature limitate. La modularità al centimetro degli arredi LAGO ha permesso di dialogare con l'architettura esistente e di valorizzare lo spazio in ogni dettaglio, ricavando ambienti vivibili come l'ampia sala da pranzo, separata dalla zona tv da un mobile cucina sospeso. Sotto il soppalco, un ampio divano componibile funge anche da letto in più per gli ospiti, permettendo di sfruttare al centimetro tutto lo spazio a disposizione senza rinunciare alla convivialità.

EVEN THE SMALLEST SPACES CAN BE FILLED WITH PERSONALITY

A mini flat in the middle of Milan becomes a tiny design-driven gem, designed around a single language that makes every detail special. This open-plan space with a loft is the refuge of a young couple that did not want to give up aesthetics and functionality in the face of limited metrage. The modularity of LAGO furnishings, designable to the centimetre, made it possible to create a dialogue with the existing architecture and make the most of the space right down to the smallest details, creating liveable spaces like the spacious dining room, which is separated from the television area by a suspended kitchen component. Beneath the loft, the large modular sofa can be transformed into a bed for guests, so that all of the space can be used without giving up conviviality.

LA PICCOLA CUCINA SOSPESA, PROGETTATA SU MISURA,
DIVIDE ZONA LIVING E SALA DA PRANZO CON LEGGEREZZA



THE SMALL SUSPENDED KITCHEN IS TAILORED TO THE SPACE,
DIVIDING THE LIVING ROOM AND DINING ROOM WITH LIGHTNESS



Air Shelf p.50 + Air Bed p.120

Nel soppalco, la sospensione è accentuata dall'utilizzo di elementi della collezione LAGO Air che poggiano su gambe in vetro, come il letto e la libreria porta tv, che lasciano la vista libera sulla sala da pranzo facendo filtrare la luce delle ampie finestre. L'assenza di ingombri importanti restituisce una grande luminosità e rende fluido il dialogo tra le zone della casa. Nel bagno, i colori accesi degli arredi sono ripresi dal lavandino Cellule che, integrando le mensole, ottimizza lo spazio di appoggio.

In the loft, the suspension of the space is accentuated with pieces from the LAGO Air collection, which are supported by glass legs, like the bed and television table, which provide an unobstructed view of the dining room below, framed by shelving the winds over the walls like ivy. The absence of bulky components lends luminosity to the space and creates a fluid dialogue between the different areas of the house. In the bathroom, the bright hues of the furnishings are picked up in the Cellule washbasin, which, with its integrated shelves, optimises the usable surface space.



Cellule Basin p.141

LASCIATI ISPIRARE E PROGETTA ASSIEME A NOI
LA CASA DEI TUOI SOGNI.

RICHIEDI UNA CONSULENZA DI PROGETTAZIONE E UN
PREVENTIVO SU LAGO.IT/CASECOMPLETE



GET INSPIRED AND DESIGN TOGETHER WITH US
THE HOUSE YOU DREAM OF.

SCHEDULE A DESIGN CONSULTATION AND
ASK FOR A QUOTE AT LAGO.IT/EN/WHOLEHOUSE



WWW.LAGO.IT/EN/WHOLEHOUSE

LAGO PRODUCTS

#9 Il design sei tu, noi forniamo l'alfabeto. Modularità, leggerezza, contrasto, vitalità, dimensione architettonica, design senza tempo. Questi sono i cromosomi del DNA LAGO; un design sistemico che riesce ad offrire soluzioni sempre differenti, costruite su misura per qualsiasi spazio ed esigenza d'uso. Con l'alfabeto LAGO puoi sviluppare una progettualità che tocca tutte le aree della casa - soggiorno, cucina, bagno, camera, cameretta e studio - e si estende anche agli altri luoghi in cui scorre la vita come uffici, bar, ristoranti, caffetterie, hotel, B&B, negozi, biblioteche, musei, gallerie.

#9 You are the design; we provide the alphabet. Modularity, lightness, contrast, vitality, architectural dimension, timelessness. These are the chromosomes of the LAGO DNA; systemic design offering solutions that are always fresh and new, made to measure for any space and any need. With the LAGO alphabet, you can develop a design concept that touches every area of the home - living room, kitchen, bathroom, bedrooms and study - and also extends to other places where you spend your life such as offices, bars, restaurants, cafés, hotels, B&Bs, shops, libraries, museums and galleries.



LAGO.IT

Scarica il catalogo LAGO PRODUCTS
all'indirizzo [lago.it/cataloghi](https://www.lago.it/cataloghi)

Download the new LAGO PRODUCTS
at [lago.it/en/catalogues](https://www.lago.it/en/catalogues)



SEDUTI, SDRAIATI, APPOGGIATI, ALLINEATI, SOSPESI...GIRA CHE TI RIGIRA È TUTTO UN ALTRO LIVING... IL TUO!

LAGO Living significa capacità di realizzare un'esperienza nuova dell'abitare in cui libertà espressiva, uso del colore, componibilità e soluzioni funzionali diventano manifestazione della personalità di chi vive la casa. Un design senza tempo, modificabile ed estendibile, crea l'opportunità di poter continuamente ripensare la propria casa.

SEATED, RECLINING, RESTING, ALIGNED, SUSPENDED... TURN IT ALL AROUND AND IT IS A WHOLE NEW LIVING ROOM... YOURS!

LAGO Living means being able to create a whole new living experience, where expressive freedom, use of colour, modularity and practical solutions all become the manifestation of the person who lives in the space. It is timeless design, changeable and extendable, creating the opportunity to rework your home at any time.



LIVING ROOM

36e8®: IL MATTONCINO
DEL CONTENERE

36e8®: *THE BUILDING BLOCK
FOR STORAGE*



LAGO.IT

Scarica il catalogo 36e8® Life Book
su [lago.it/cataloghi](https://www.lago.it/cataloghi) e crea
il tuo 36e8®.

*Download the 36e8® Life Book
catalogue at [lago.it/en/catalogues](https://www.lago.it/en/catalogues)
and create your own 36e8®.*



36e8® Storage

Design Daniele Lago - 2003

UN SISTEMA MODULARE BASATO SUL QUADRATO

Un sistema di contenimento altamente modulare che permette di creare per gli ambienti living pareti attrezzate, mobili tv e madie, declinabile anche nelle altre aree della casa. Basato su un modulo quadrato di 36,8 cm di lato, consente di progettare in completa libertà, adattandosi a stili e gusti diversi e invitando ad esprimere la propria personalità. L'anta finemente profilata elimina la presenza di maniglie e la rigorosa costruzione a 45° con filigrana in alluminio impreziosiscono il contenitore, testimoniandone l'originalità e garantendo perfezione formale e solidità.

A MODULAR SYSTEM BASED ON THE SQUARE

A highly modular storage system that lets you create wall compositions, television tables and sideboards for the living room and every other room in the house. Based on a square module 36.8 cm per side, the system lets you in design in total freedom, adapting to different styles and tastes and inviting you to express your own personality. The finely finished door eliminates the need for a handle and the rigorous 45° aluminium joint construction refines the module, revealing its innovative originality and ensuring its formal perfection and solidity.



NEW



36e8® Wildwood

Design Daniele Lago

UN LEGNO ANCESTRALE

Wildwood conferisce matericità alla composizione, grazie a venature tridimensionali di un rovere centenario termotrattato. Le ante testimoniano lo spessore del legno nobile e la pregiata tecnica di costruzione massellata.

ANCESTRAL WOOD

Wildwood lends a material presence to the piece, with the tactile grain of century-old heat-treated oak. The doors express the thickness of the fine wood and the fine, bloomed construction.



36e8® Glass Storage

Design Daniele Lago



36e8® Side Storage

Design Daniele Lago



TALKING FURNITURE

L'Internet of Things entra nel mondo dell'arredo: scarica l'app "LAGO DESIGN", avvicina lo smartphone al chip NFC e dialoga con gli arredi LAGO.

TALKING FURNITURE

The Internet of Things makes its entry into the world of furniture: Download the app "LAGO DESIGN", hover your smartphone over the NFC chip, start talking with LAGO furniture.



IL DESIGN HA MOLTE FACCE

36e8® Side aggiunge nuove possibilità all'utilizzo del colore, personalizzando un lato o il frontale in uno dei 32 colori LAGO.

A MANY-FACED DESIGN

36e8® Side adds new possibilities through the addition of colour, customising either one side or the door of the module in one of the 32 LAGO colours.



Air Sofa

Design Daniele Lago - 2010 / Patented Product



IL DIVANO MODULARE SU MISURA PER I TUOI SPAZI

Una gamma infinita di schienali e sedute per creare il divano perfetto per i propri spazi. Grazie al telaio in alluminio e agli agganci brevettati, il divano è completamente riconfigurabile e può assumere un volto sempre nuovo. Grande attenzione è stata posta all'ergonomia e all'ecosostenibilità di materiali e processi. Le gambe in vetro rendono l'imbottito aereo.

A MODULAR SOFA TAILORED TO YOUR SPACE

An infinite range of backs and seats for designing the perfect sofa for your space. Thanks to its aluminium frame and patented fastening system, the sofa can be completely reconfigured for a whole new look any time. The sofa has an ergonomic design and is made using eco-sustainable materials and processes. The glass legs give this upholstered piece an airy feel.





LAGO.IT

Guarda il video dei divani Air su
lago.it/design/divano-air
 e scopri tutta la loro modularità.

*Watch the Air Sofas video at
lago.it/en/design/air-sofa
 and find out all about their
 extreme modularity.*

RICONFIGURABILE

Un innovativo telaio in alluminio e la grande modularità di sedute e schienali permettono infinite configurazioni da modificare liberamente in base alle esigenze.

RECONFIGURABLE

The innovative aluminium frame and total modularity of the seats and backs lend themselves to infinite configurations, which can be freely changed based on need.





Air Wildwood Sofa

Design Daniele Lago - 2017

UN DIVANO SENZA TEMPO

Un divano modulare dotato di uno scenografico schienale in legno rovere Wildwood disallineato a cui sono appoggiati soffici cuscini in piuma, riposizionabili a piacere. Grazie allo schienale, rifinito completamente anche sul retro, il divano Air Wildwood rappresenta una soluzione adatta sia in appoggio a muro sia a centro stanza. Il calore del legno, ricco di venature, dialoga con l'essenzialità delle sedute.

A TIMELESS SOFA

A modular sofa featuring a stunning, off-centre Wildwood back, made comfortable with soft feather pillows that can be repositioned whenever and however you like. Thanks to its back, which is completely finished on both sides, the Air Wildwood sofa can be set against a wall or in the middle of the room. The warmth of the wood grain dialogues with the essentiality of the seats.



Slide Sofa

Design Daniele Lago - 2014



IL CORAGGIO DELLA GEOMETRIA

Le sedute e gli schienali, costituiti da moduli a trapezio, sono liberamente accostabili per ottenere un divano dalle infinite forme e configurazioni, in grado di inserirsi negli ambienti con personalità.

GEOMETRIC BOLDNESS

The seats and backs, made of trapezium-shaped modules, can be combined any which way, for a sofa with infinite forms and configurations, filling the room with personality.

Lastika Armchair

Design Velichko Velikov / Lago Studio - 2011

UNA SEDUTA COLORATA

Bella come un fiore, divertente come un gioco. Quaranta elastici rendono una seduta da interni un'esperienza giocosa.

A COLOURFUL ARMCHAIR

Pretty as a flower, fun as a game. Forty elastic bands make this indoor chair a playful experience.

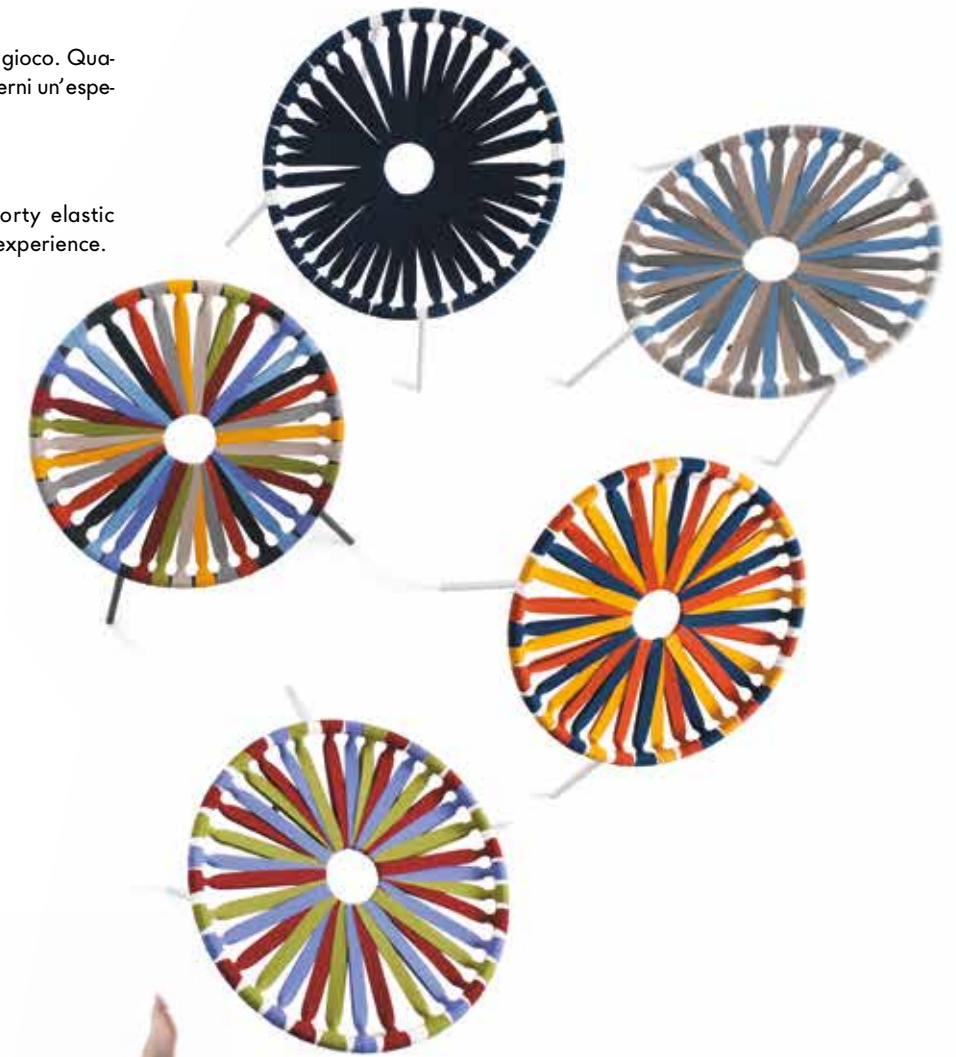

AIR SYSTEM: LA LIBRERIA CHE SFIDA
LA FORZA DELLA GRAVITÀ

*AIR SYSTEM: SHELVING THAT
CHALLENGES THE FORCE OF GRAVITY*

Air Shelf & Storage

Design Daniele Lago - 2006

SI INVERTE L'ORDINE DEI FATTORI

Mensole a forte spessore e contenitori sostenuti da trasparenti strutture in vetro temperato: un gioco di contrapposizioni che trasmette leggerezza. Completamente self-standing e bifacciale, trova posto anche a centro stanza per dividere gli ambienti in modo elegante e aereo.

WE INVERTED THE ORDER OF FACTORS

Thick shelves and containers supported by transparent structures in tempered glass, a play of opposites that transmits lightness. Extremely light supporting structures in transparent glass, and full physicality in the elements being supported. Two-faced, it can also be set up in the middle of the room to divide living spaces in an airy and stylish way.





Air Wildwood Storage

Design Daniele Lago



IL CALORE DEL LEGNO

Volumi in caldo legno di rovere dialogano con forme laccate e in vetro colorato, generando composizioni regolari o disallineate che danno movimento all'interior.

THE WARMTH OF WOOD

Warm oak volumes dialogue with lacquered or coloured glass shapes, generating aligned or misaligned compositions that lend movement to the interior.

LagoLinea Shelf

Design Daniele Lago - 2009 / Patented Product



UNA LIBRERIA DA COSTRUIRE CON UNA LINEA

LagoLinea ha rivoluzionato il concetto di libreria statica a griglia, consentendo di creare sagome figurative o classiche sempre connotate da una grande leggerezza. Libera da vincoli strutturali che limitano la capacità espressiva, permette di organizzare gli spazi in modo creativo e funzionale.

A SHELF MADE UP OF A SINGLE LINE

Extremely light supporting structures in transparent glass, and full physicality in the elements being supported. Two-faced, it can also be set up in the middle of the room to divide any living spaces in an airy and stylish way. Free from structural restrictions that limit expression, it lets you organise spaces creatively and functionally.



+

Si adatta agli spazi in maniera naturale, offrendo la massima libertà espressiva.

It adapts naturally to spaces, offering maximum expressive freedom.



Morgana Storage

Design Daniele Lago - 1996

UNA CASSETTIERA SCULTURA,
FIGLIA DELLA MOBILITÀ

A FULLY MOBILE SCULPTURE-LIKE
CHEST-OF-DRAWERS





Chama Armchair & Sofa

Design Mi Jin Park / LAGO Studio - 2011

LA POLTRONA DIVENTA UN COMODO LETTO

THE ARMCHAIR BECOMES A COMFY BED



30mm Shelf & Storage

Design Daniele Lago - 2006 / Patented Product

UNA LIBRERIA IN EVOLUZIONE

30 mm è lo spessore della libreria, a terra o sospesa, che si può integrare con i contenitori del sistema 36e8®, offrendo soluzioni di contenimento funzionali e modulari per sfruttare lo spazio al centimetro.

AN EVOLVING BOOKSHELF

The bookshelf is 30 mm thick, can be placed on the floor or suspended and integrates with the 36e8® system, offering functional, modular storage solutions that let you design your space down to the centimetre.



+

LA PRIMA LIBRERIA SOSPESA

Una libreria elevata per la prima volta da terra grazie alla sospensione dei fianchi diventa leggera e dinamica.

THE FIRST SUSPENDED BOOKSHELF

Raised up off the ground for the first time, the suspended sides make the bookshelf light and dynamic.





30mm Weightless Shelf

Design Daniele Lago

SOSPENSIONE SURREALE

Le librerie scendono dal soffitto come stalattiti, creando una soluzione aerea ed elegante per organizzare e dividere l'ambiente.

SURREAL SUSPENSION EFFECT

Shelves and storage units come down from the ceiling like stalactites, providing a particularly aerial and elegant way of dividing the room.



Et Voilà Storage

Design Daniele Lago - 2011 / Patented Product

NASCE L'ARREDAMENTO VESTIBILE

Un cambio di prospettiva all'idea di mobile che, per la prima volta, integra il tessuto come elemento strutturale ed estetico. Un tessuto teso chiude un volume facendo perdere completamente la percezione delle ante e sorprende rivelando, con un semplice gesto, gli ampi contenitori.

THE "DRESSABLE" FURNITURE WAS BORN

A change of perspective in furniture that, for the first time, integrates fabric as a structural and aesthetic element. Taut fabric closes the volumes, completely doing away with the perception of doors and surprising us when it reveals, with a simple gesture, the ample spaces inside.

WINNER OF GOOD DESIGN AWARD 2011

Net Storage

Design Daniele Lago - 1997

UN CUBO, DUE CUBI, INFINITI CUBI

Il sistema modulare NET è costituito da una rete di cubi di 40 cm per lato, che si combinano offrendo a ognuno l'opportunità di creare una libreria personalizzata. Il perno di congiunzione verticale tra un cubo e l'altro consente la rotazione di ogni singolo elemento. NET si adatta con facilità ai diversi ambienti, aiutando a dividere le diverse aree della casa e creandone di nuove.

ONE CUBE, TWO CUBES, INFINITE CUBES

The modular NET system is made up of a network of cubes measuring 40 cm per side, which anyone can combine to create a customised bookcase. The vertical pin that joins each cube to the next makes it so that every single element can be rotated. NET easily adapts to different settings, helping divide the various areas of the home and create new ones.



Huggy Armchair

Design Brit Leissler / Lago Studio - 2007

LA POLTRONA ACCOGLIE, AVVOLGE E IN POCHI GESTI DIVENTA UN COMODO LETTO IN PIÙ

AN INVITING, ENVELOPING ARMCHAIR THAT CAN QUICKLY BECOME A COMFY EXTRA BED



WINNER OF GOOD DESIGN AWARD 2009

LA VITA CHE ACCADE ATTORNO AL TAVOLO È PIÙ IMPORTANTE DEL TAVOLO STESSO

Punto d'incontro tra l'intimità domestica e il piacere di condividere momenti di convivialità in famiglia o con gli amici, la sala da pranzo LAGO è lo snodo privilegiato che ospita e celebra le relazioni offrendo nuove letture dello spazio e del tempo. Elementi di sorpresa come arredi leggeri e fluttuanti accompagnano la condivisione: attorno a un tavolo si sperimentano nuove alchimie materiche ed emozionali.

WHAT HAPPENS AROUND THE TABLE IS MORE IMPORTANT THAN THE TABLE ITSELF

A meeting point between domestic intimacy and the pleasure of socialising with family or friends, the LAGO dining room is a special space that hosts and celebrates relationships, offering new readings of space and time. Surprising elements like suspended, floating furniture encourage sharing and offer the experience of new material and emotional alchemies around the table.

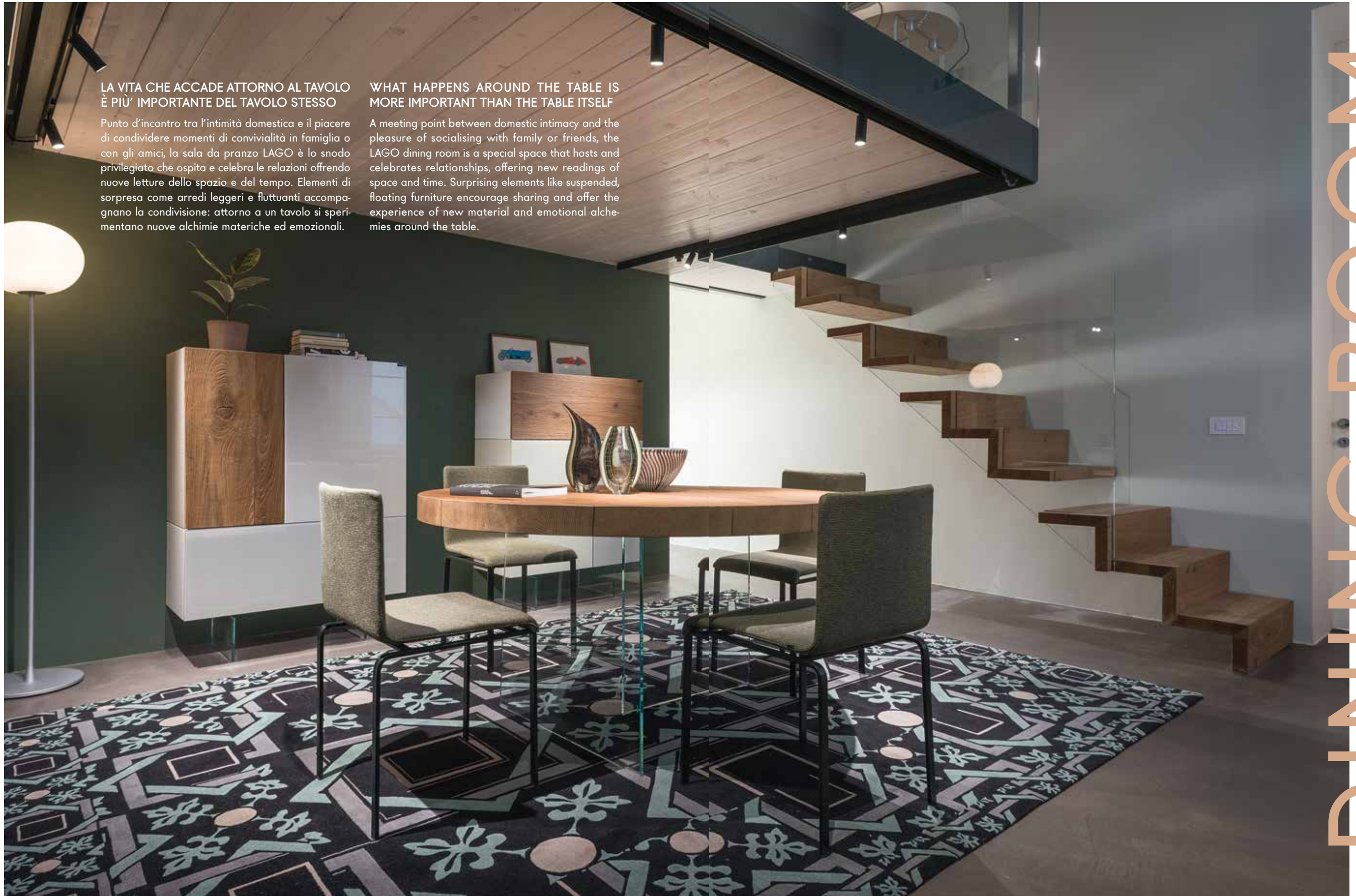

DINING ROOM

Sideboards

Design Daniele Lago



MADIE DALL'ELEGANZA ESSENZIALE

Il mondo del contenimento modulare del sistema 36e8® e la leggerezza del sistema Air creano eleganti madie sospese o appoggiate a terra, che acquistano nuove vitalità di forme, generando composizioni ben definite.

SIDEBOARDS WITH ESSENTIAL ELEGANCE

The modularity of 36e8® storage and the lightness of the Air system create elegant sideboards, either suspended or resting on the floor, filled with fresh formal vitality and generating strong compositions.

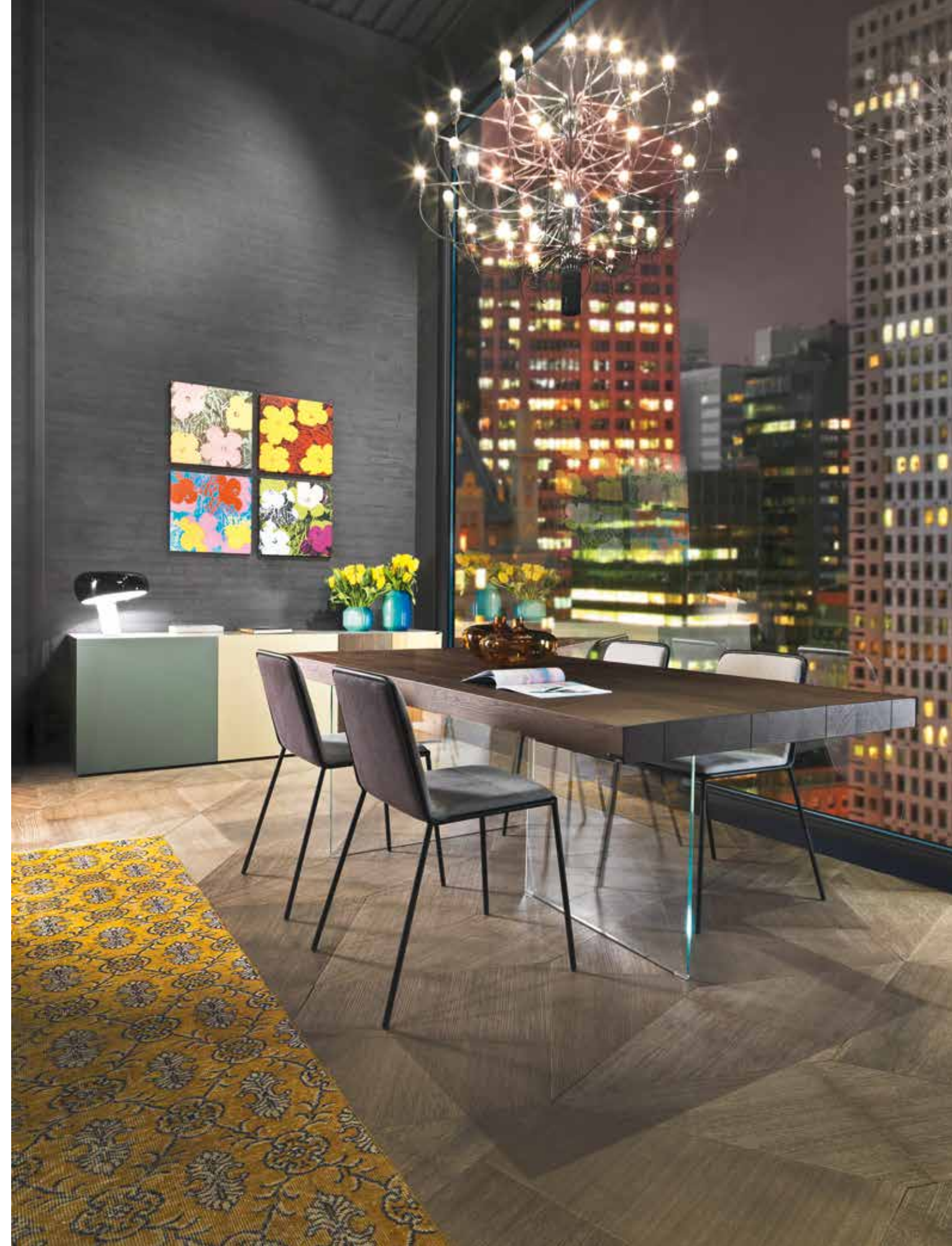



Air Wildwood Table

Design Daniele Lago - 2006

IL TAVOLO CON UN'ANIMA

Essenziale e sorprendente, il tavolo Air sembra fluttuare nell'aria. Il piano di rovere centenario ha un'anima piena di vita da raccontare, grazie alle venature tridimensionali del legno termotrattato che risulta estremamente resistente. Sorretto da trasparenti gambe in vetro temperato, il piano è disponibile anche in altri materiali e finiture.

THE TABLE WITH A SOUL

Essential and surprising, the Air table seems to float in air. The century-old oak surface has its own story to tell through the tactile grain of the wood, which is heat-treated to make it extremely resistant. Supported on transparent, tempered-glass legs, the tabletop is also available in other materials and finishes.

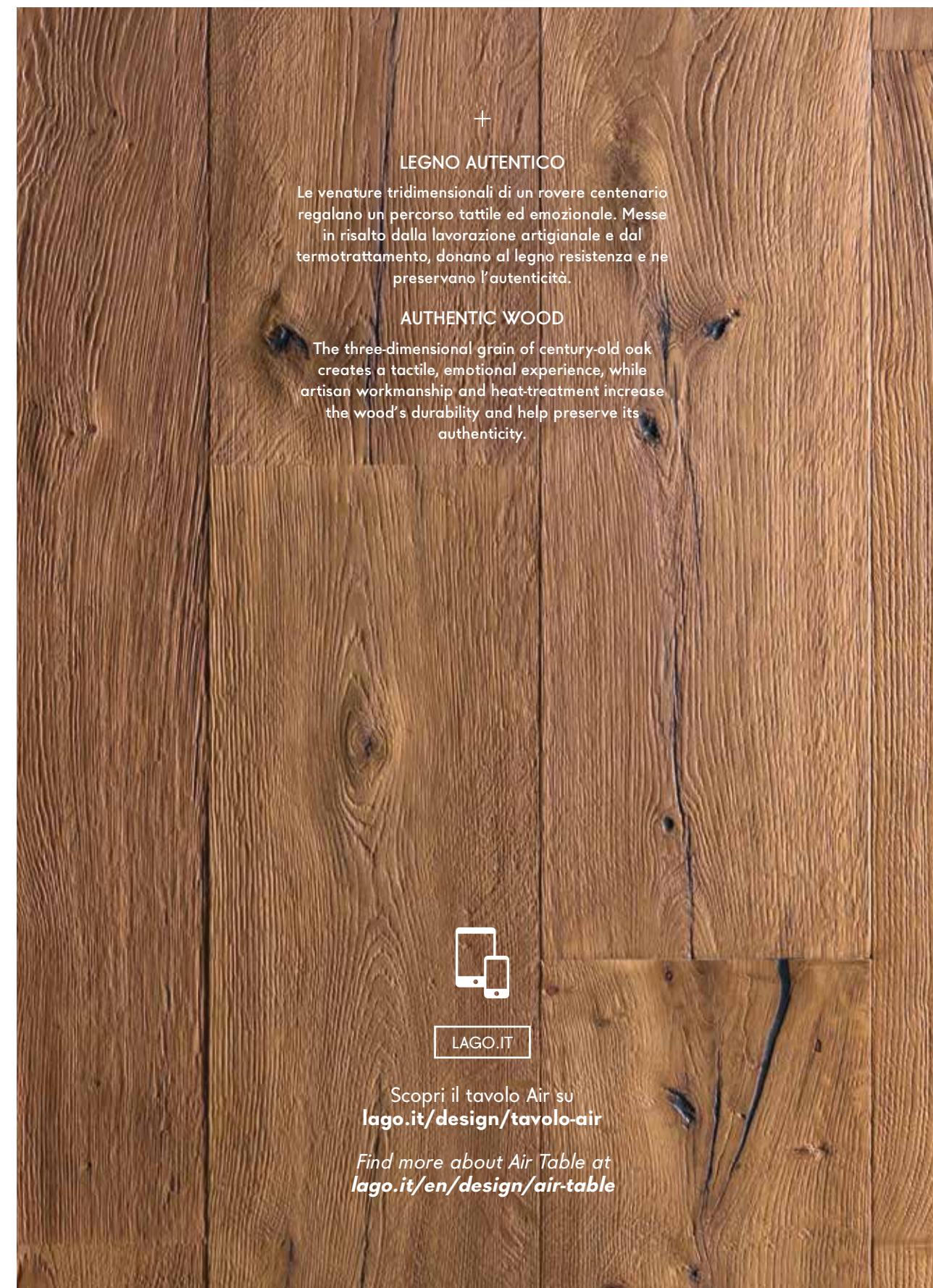

+

LEGNO AUTENTICO

Le venature tridimensionali di un rovere centenario regalano un percorso tattile ed emozionale. Messe in risalto dalla lavorazione artigianale e dal termotrattamento, donano al legno resistenza e ne preservano l'autenticità.

AUTHENTIC WOOD

The three-dimensional grain of century-old oak creates a tactile, emotional experience, while artisan workmanship and heat-treatment increase the wood's durability and help preserve its authenticity.



LAGO.IT

Scopri il tavolo Air su
[lago.it/design/tavolo-air](https://www.lago.it/design/tavolo-air)

Find more about Air Table at
[lago.it/en/design/air-table](https://www.lago.it/en/design/air-table)



+

ELEGANTE SOSPENSIONE

I volumi scultorei delle madie, appoggiati su vetro trasparente, donano leggerezza alla sala da pranzo.

ELEGANT SUSPENSION

The sculptural volumes of the sideboards, supported by transparent glass, add airy lightness to the dining room.



Pletra Chair

Design Daniele Lago - 2017



NEW



UNA SEDIA IMBOTTITA, COLORATA ED ESSENZIALE

Una struttura metallica esile ed elegante racchiude un cuore imbottito che permette il rivestimento differenziato su due facce. La struttura snella regala un elevato comfort grazie alla seduta in legno curvato rivestito con una generosa imbottitura. Rivestibile con tutti i tessuti, pelli ed ecopelli LAGO, Pletra è una sedia che permette una vasta abbinabilità con diversi tipi di interior e di tavoli, trovando con facilità collegamenti all'ambiente in cui è inserita.

AN UPHOLSTERED CHAIR, COLOURED AND ESSENTIAL

A slender, elegant frame encloses an upholstered core, so that each side can be covered with a different colour. The sleek structure offers extra comfort thanks to the generously filled upholstered curved wood seat. Pletra can be covered in any of the LAGO fabrics, leathers and eco-leathers, making it easy to pair with a vast range of interiors and tables, effortlessly creating links with other components in the room.



Air Table Rounded Version

Design Daniele Lago - 2016

LA FORMA PERFETTA PER CONDIVIDERE

Sospeso su invisibili gambe in vetro, il tavolo Air tondo sembra un disco che galleggia nell'aria. La sua forma circolare crea un'atmosfera accogliente in casa, favorendo la conversazione e la condivisione fra le persone. Le linee sinuose ed essenziali trovano solidità nel piano del tavolo che nasconde il sistema di fissaggio ed è curato nei minimi dettagli. Il piano è disponibile in vetro lucido o in Wildwood.

THE PERFECT SHAPE FOR SHARING

Suspended on invisible glass legs, the round Air table seems like a disk floating in the air. Its circular shape creates a welcoming atmosphere in the home, fostering conversation and sharing. The sinuous, essential lines find solidity in the table top, which conceals the fastening system and results from attention paid down to the smallest detail. The top is available in shiny glass and Wildwood.





NEW



NEW

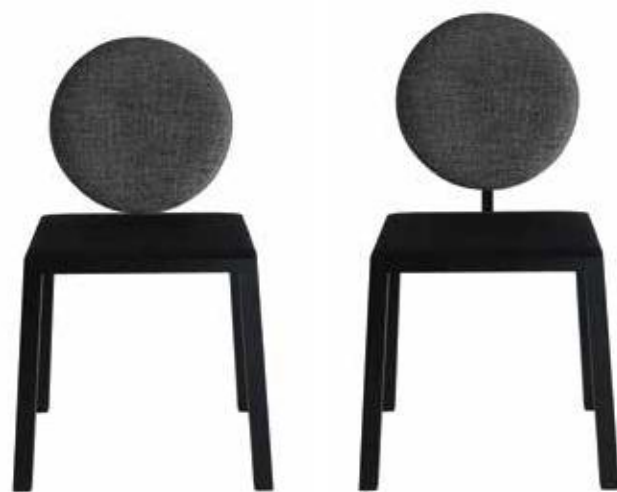

Lift Chair

Design Daniele Lago - 2017

COMFORT SU MISURA

Una sedia dalle forme classiche resa contemporanea da un punto di contatto a zero millimetri tra la seduta e il cerchio dello schienale. Il comfort è garantito dalla seduta imbottita ed è reso personalizzabile attraverso un innovativo supporto interno che permette la regolazione in altezza dello schienale in 7 posizioni con un semplice gesto della mano.

CUSTOMISED COMFORT

A chair with classical forms made contemporary by zero-millimetre contact between the seat and the circle that forms the seat back. Comfort is guaranteed by the upholstered seat, and the chair is customisable thanks to an innovative internal frame that lets you quickly and easily regulate the height of the seat back.



Vertigo Table

Design Daniele Lago - 2017

GIOCHI DI EQUILIBRIO

Un tavolo dalla forma pulita ed essenziale che crea un suggestivo senso di sospensione, giocando con la sottrazione alla vista di un elemento portante: una gamba. La superficie costituita da doghe in legno di rovere laccato a poro aperto rende profondo e materico il colore.

BALANCE GAMES

A table with clean, essential lines that creates an evocative sense of suspension, playing on the apparent absence of one of its legs. The wood-slat surface, in lacquered, open pore oak, gives the colour depth and materiality.

Air Wildwood Table Extendable Version

Design Daniele Lago

IL TAVOLO CHE FLUTTUA AGGIUNGE SPAZIO AGLI OSPITI

Un inno alla socialità e alla condivisione: i tavoli Air e Air Wildwood nella versione allungabile aggiungono da 2 a 4 posti a sedere. Disponibile in Wildwood o laccato per le diverse esigenze di interior.

A FLOATING TABLE WITH SPACE FOR GUESTS

A hymn to socialising and sharing: the extendable version of the Air and Air Wildwood tables can accommodate 2 or 4 extra guests. Available in Wildwood and lacquer to suit a vast range of interiors.



Loto Table

Design Franco Lago - 2014

L'OSPITALITÀ SBOCCIA COME UN FIORE DI LOTO

Un tavolo quadrato che si apre come un fiore passa da 4 a 8 posti a sedere. Quattro prolunghe triangolari, laccate nei colori LAGO o in Wildwood sono nascoste sotto al top in Wildwood laccato.

HOSPITALITY OPENS UP LIKE A LOTUS BLOSSOM

A four-sided table that unfolds like a flower, passing from seating for 4 to seating for 8. Four triangular extensions, lacquered in LAGO colours or in Wildwood hide beneath the Wildwood or lacquered tabletop.



Dangla Chair

Design Luca De Bona / LAGO Studio - 2011

UNA SEDIA DA VESTIRE

Liscia, arricciata o con zip, la sedia è vestibile con tutti i tessuti LAGO e capace di adattarsi ad ogni progetto d'interior. Un affusolato telaio metallico, flettendo, collabora per garantire il massimo comfort.

A DRESSABLE CHAIR

Smooth, 'curly' or with a zip, this chair can be 'dressed' in any of the LAGO fabrics and adapts to any kind of interior. The streamlined metal frame flexes to offer maximum comfort.



Joynt Chair

Design Harry Howen / Lago Studio - 2012

UNA SEDIA FLESSIBILE

Una forma inaspettata sorprende per la capacità dello schienale di flettersi e di interagire assecondando i movimenti del corpo, restituendo una sensazione di grande comfort.

A FLEXIBLE CHAIR

An unexpected shape with a surprise in store: the back is flexible and follows the body's movement, making the seat extremely comfortable.

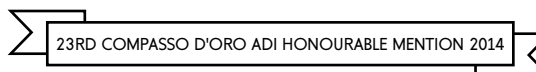



INFINITAMENTE MODULARE E SEMPRE FUNZIONALE: PENSATA PER LE PERSONE CHE LA VIVONO

Le cucine LAGO sono progettate attorno alla gestualità e creatività del cucinare. A isola, penisola, sospesa o rotonda, la cucina LAGO offre una grande libertà compositiva, dando vita a un linguaggio flessibile in grado di adattarsi a gusti ed esigenze diverse. Purezza dei volumi, sospensioni leggere e alchimia dei materiali permettono di creare composizioni su misura per la propria personalità.

INFINITELY MODULAR AND ALWAYS FUNCTIONAL: DESIGNED FOR THE PEOPLE WHO USE IT

LAGO kitchens are designed around the gestures and creativity of cooking. Island, peninsula, suspended or round: the LAGO kitchen offers full compositional freedom and a flexible language that can adapt to suit any style and need. Pure volumes, airy suspensions and material alchemies let you create compositions tailored to your own personality.

KITCHEN



36e8® Wildwood Kitchen

Design Daniele Lago - 2008 / Patented Product

IL LEGNO NATURALE VIVE CON TE

Un legno autentico cela una raffinata anima tecnologica e conferisce alla cucina calore e senso di ospitalità. La costruzione delle ante, accoppiate a un profilo in alluminio, garantisce solida funzionalità. Un segno impercettibile disegnato sull'anta cela la maniglia invisibile Flapp che lascia le forme degli arredi pulite ed essenziali.

NATURAL WOOD LIVES WITH YOU

Authentic wood that conceals a sophisticated technological soul and fills the kitchen with warmth and a feeling of hospitality. The construction of the doors together with the brushed aluminium joint ensure solid functionality. An imperceptible mark on the door conceals the invisible Flapp handle, which keeps the surface of the components clean and essential.



WINNER OF GOOD DESIGN AWARD 2009

+

ANTA TECNOLOGICA

Un'anima tecnologica in alluminio supporta e protegge l'anta in Wildwood.

TECHNOLOGICAL DOORS

A technological aluminium interior supports and protects the Wildwood door.



Steps Stool & Chair

Design Monica Graffeo / LAGO Studio - 2008

SEDIE E SGABELLI DALL'ASPETTO LEGGERO MA MATERICO GRAZIE AL FELTRO

L'utilizzo di un materiale inaspettato ed innovativo come il feltro, sorretto da una struttura in acciaio verniciato, permette di ottenere una seduta confortevole dalla forma elegante e pulita.

SEATS AND STOOLS WITH A LIGHT, BUT AT THE SAME TIME MATERIAL APPEARANCE THANKS TO THE FELT STRIPS

Use of an unexpected and innovative material like felt, supported by a painted steel structure, results in a comfortable chair with clean, elegant lines.





N.O.W. Storage

Design Daniele Lago - 2006

LA DISPENSA ARMADIO

La dispensa diventa un elegante volume monolitico: l'assenza di maniglie e le fasce in vetro colorato esaltano la superficie perfetta ed eliminano la percezione delle singole ante, conferendo all'arredo una nuova e inattesa dimensione architettonica. La dispensa N.O.W. ha una modularità tendente all'infinito, adattabile a qualsiasi spazio e personalizzabile nelle sequenze cromatiche.

THE WARDROBE LARDER

The larder as an elegant monolithic volume. The handle-free coloured glass bands enhance the perfection of the surface and eliminate the perception of individual doors, giving the piece a fresh and unexpected architectural dimension. The N.O.W. larder is infinitely modular and it can be adapted to any space and the colour sequences are fully customisable.

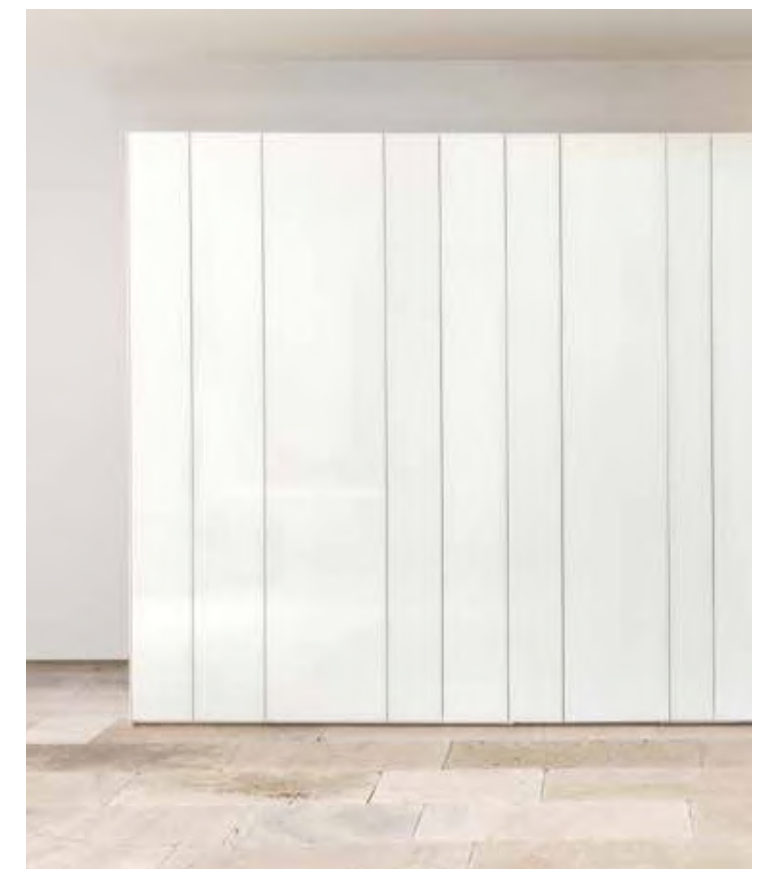

+

TUTTO IN ORDINE

Sono gli accessori, spesso nascosti e patrimonio esclusivo dello chef di casa, a completare un sistema innovativo come le soluzioni LAGO per la cucina. Non solo rispondendo in modo efficiente alle necessità organizzative e alla gestualità del cucinare, ma rendendo tutto ciò speciale grazie all'utilizzo di soluzioni ergonomiche sorprendenti.

KEEP IT TIDY

Accessories, which are often hidden and the exclusive domain of the chef of the house, are what complete innovative kitchen systems like that of the LAGO kitchen. They not only respond effectively to the chef's organisational needs and the actual activity of cooking, but also make it all special through surprising ergonomic solutions.

**36e8® Weightless Kitchen**

Design Daniele Lago

TECNICA ANTIGRAVITAZIONALE

I pensili modulari della cucina 36e8® Weightless vengono fissati a soffitto tramite una speciale piastra che assicura facilità di montaggio, stabilità e sicurezza. Cappa e scolapiatti sono integrati ai contenitori che scendono al soffitto, diventando una soluzione pratica e innovativa per la cucina.

ANTIGRAVITATIONAL TECHNOLOGY

The modular wall units of the 36e8® Weightless Kitchen attach to the ceiling with a special plate that ensures ease of installation, stability and safety. The hood and dish drainer are integrated into the ceiling-mounted modules, creating an innovative, practical solution for the kitchen.



36e8® MadeTerraneo Kitchen

Design Daniele Lago

TUTTO IL CALORE DEL MEDITERRANEO

La cucina coniuga antichi materiali e innovativi utilizzi: la piastrella in ceramica dipinta a mano, elemento tipico della cultura mediterranea, diventa il modulo base di top e penisole che, come una composizione di pixel in configurazioni irregolari, danno movimento e colore all'ambiente cucina.

ALL THE WARMTH OF THE MEDITERRANEAN

A kitchen that unites traditional materials with innovative uses. Hand-painted ceramic tile, a typical element of Mediterranean culture, is the base module for tops and peninsulas that, like a pixel composition in irregular configurations, bring movement and colour to the kitchen.



36e8® Steel+ Kitchen

Design Daniele Lago

UN ACCIAIO VIVO

Un progetto che nasce per dare nuovo carattere e calore all'acciaio, materiale nobile e altamente tecnico, adatto ad essere impiegato in uno degli ambienti della casa più sollecitati all'uso. La lavorazione, che integra diversi spessori, e la finitura della superficie offrono soluzioni progettuali originali, arricchite dalla combinazione con materiali quali il legno Wildwood e il vetro.

STEEL WITH A PULSE

Steel+ was designed to give new character and warmth to a fine, highly technical material well suited for use in one of the most highly used rooms in the home. The processing, which integrates different thicknesses, and the surface finish offer original design options, further enriched in combination with materials like Wildwood and glass.



UNA CUCINA A ISOLA CHE
RIMETTE IL "FUOCO" AL CENTRO
DEL PAESAGGIO DOMESTICO

AN ISLAND KITCHEN THAT PUTS
"FIRE" BACK INTO THE HEART OF
THE DOMESTIC LANDSCAPE



Air Kitchen

Design Daniele Lago - 2016

UN INNO ALL'EMPATIA E ALLA CONVIVIALITÀ DECLINATO IN UN CERCHIO

La cucina a isola Air mette al centro della scena lo scambio fra le persone, favorendo un dialogo diretto tra chi cucina e chi partecipa alla magica ritualità della preparazione del cibo sia attraverso la relazione visiva, che di vicinanza con il cuoco. Sospesa su gambe in vetro trasparente, con piano di cottura a induzione è abbinabile al sistema cucina 36e8®. Disponibile con piano in vetro lucido o in Wildwood.

A HYMN TO EMPATHY AND CONVIVIALITY IN CIRCULAR FORM

The Air island kitchen gives exchanges between people a starring role, fostering dialogue between those who cook and those who participate in the magic rituality of food preparation, both visually and through vicinity to the cook. Suspended on transparent glass legs, and with an induction hob, it can be paired with the 36e8® kitchen system. Available with a shiny glass or Wildwood counter.

WINNER OF SALONE DEL MOBILE.MILANO AWARD 2016



LAGO.IT

Guarda il video della cucina Air su
lago.it/design/cucina-air e scopri
quanto può essere conviviale.

Watch the video about the Air kitchen at
lago.it/en/design/air-kitchen
and discover how social it can be.

UNA CAMERA DA LETTO SOSPESA ALL'ALTEZZA DEI TUOI SOGNI

Innovazione e sorpresa sono i segni distintivi dello spazio dedicato al riposo e all'intimità. Armadi da vestire, letti sospesi e leggeri dialogano con complementi flessibili e modulari: qui i sogni prendono forma e l'area più nascosta della casa diventa luogo di emozioni inconsuete.

A SUSPENDED BEDROOM MAKING DREAMS REALITY

Innovation and surprise are the distinctive traits of the LAGO bedroom, a space dedicated to rest and intimacy. Dressable wardrobes and suspended, airy beds dialogue with flexible, modular pieces, bringing dreams to life and making the most hidden room in the house a place of unexpected emotions.



BEDROOM



N.O.W. Wardrobe

Design Daniele Lago - 2006 / Patented Product



L'ARMADIO PERSONALIZZABILE ALL'INFINITO

La superficie scandita dal ritmo irregolare delle fasce in vetro e l'assenza di maniglie eliminano la percezione dell'armadio e danno vita ad un volume dinamico che diventa elemento di architettura d'interni. L'apertura con una leggera pressione della mano grazie a un sistema brevettato rende inaspettata la fruizione dell'armadio. La modularità delle fasce permette una personalizzazione di serie della misura e regala libertà espressiva grazie agli infiniti mood cromatici.

AN INFINITELY CUSTOMIZABLE WARDROBE

The surface, marked out by the irregular rhythm of the glass bands, and the absence of handles eliminate the perception of the wardrobe, creating a dynamic volume that becomes an element of interior architecture. Thanks to a patented opening mechanism, the wardrobe opens with slight pressure from the hand. And the modularity of the bands lets you customise the dimensions while offering freedom of expression through an infinity of possible chromatic moods.



+

APERTURA BREVETTATA

La leggera flessione di alcune fasce in vetro permette un'apertura piacevole e innovativa, che mantiene le sue caratteristiche all'infinito.

PATENTED OPENING

The wardrobe opens with the slight flex of a few glass bands, a pleasant, innovative solution that will always function just like it did on day one, forever.

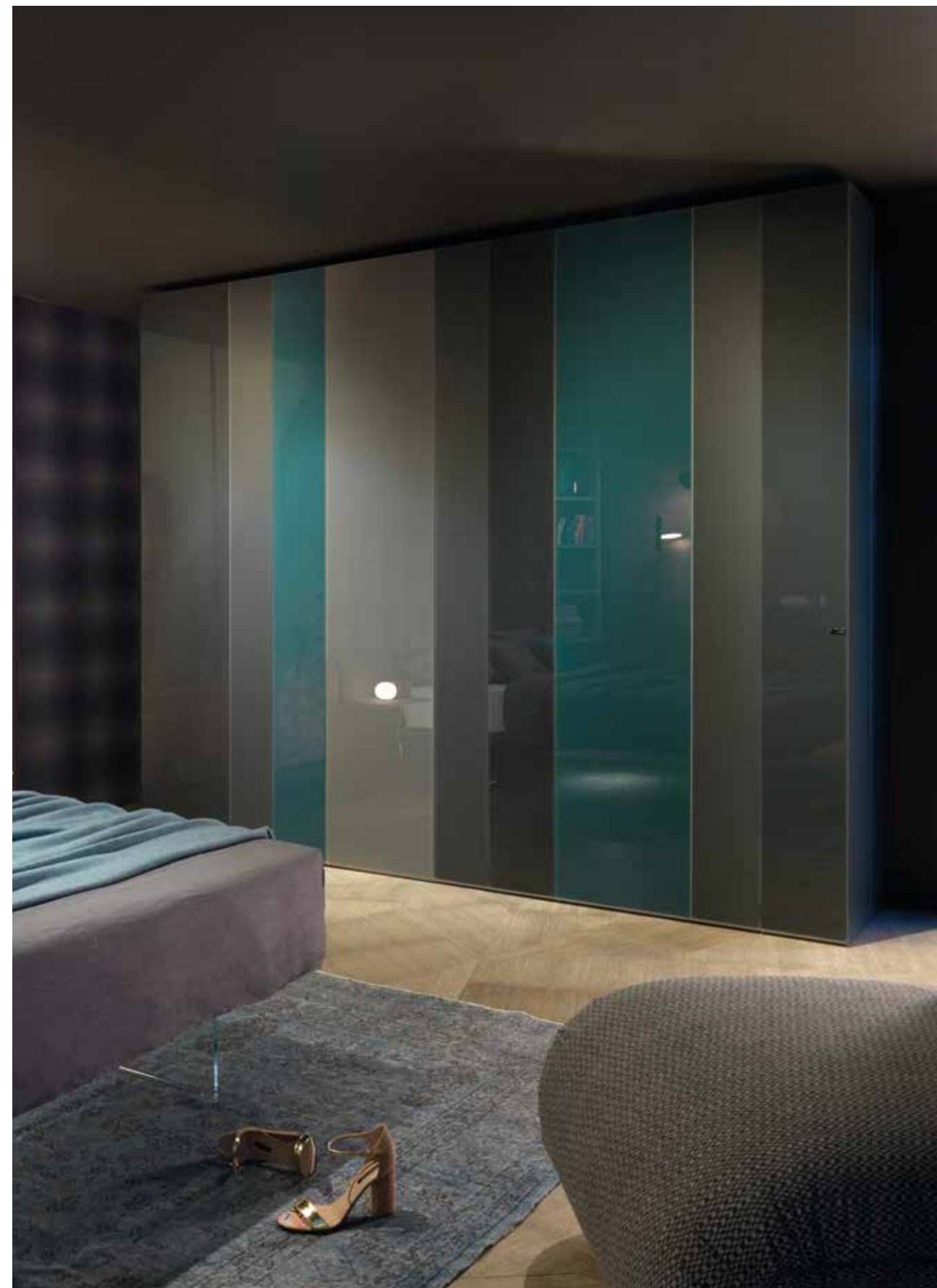



Et Voilà Wardrobe

Design Daniele Lago - 2011 / Patented Product



L'UNICO ARMADIO VESTIBILE AL MONDO

Un tessuto teso di grandi dimensioni sostituisce le ante eliminando la percezione dell'armadio, che scompare e diventa una raffinata parete tessile. Et Voilà sorprende, rivelando con un semplice gesto gli ampi interni, scoperti completamente grazie all'apertura totale dell'anta. Un armadio sartoriale, progettabile al millimetro, che permette di cambiare facilmente il look alla stanza.

THE WORLD'S ONLY DRESSABLE WARDROBE

A vast swath of taut fabric replaces the doors, eliminating the perception of the wardrobe, which disappears and becomes a refined fabric wall. With a simple gesture, Et Voilà surprises, revealing a spacious interior fully laid bare by the end-to-end opening of the door. A sartorial wardrobe that can be designed down to the millimetre and lets you easily change the look of the room.







+

DUEE WARDROBE

Un armadio scorrevole in cui due volumi architettonici si compenetrano.

DUEE WARDROBE

A sliding-door wardrobe with two co-penetrating architectural volumes.

Fluttua Bed

Design Daniele Lago - 2004 / Patented Product



ABBIAMO ELIMINATO TUTTO IL SUPERFLUO

Il primo letto sospeso al mondo che sfida la forza di gravità, dando forma all'emozione di dormire galleggiando nell'aria. Un unico sostegno centrale, regolabile in altezza, sostiene il telaio e l'innovativo pianale in HPL che risulta impercettibile alla vista. Nessun ingombro esterno al materasso, nessun rigido ostacolo che limiti il fluire dello spazio nella stanza, facilitandone al massimo la pulizia e l'igiene. L'accurato studio ingegneristico permette l'installazione sui diversi tipi di muri e pareti in cartongesso, e i severi test garantiscono il massimo livello di sicurezza per chi dorme.

WE GOT RID OF EVERYTHING SUPERFLUOUS

The first suspended bed in the world that challenges the force of gravity, creating the sensation of sleeping while floating on air. A single central support, of adjustable height, holds up the frame and innovative HPL platform, which is imperceptible to the eye. No bulk outside the mattress, no hard obstacles limiting the flow of space in the room. It could not be easier to keep clean and hygienic. Thanks to the meticulous engineering underpinning the design, it can be installed on different kinds of walls and plasterboard, and the severe testing guarantees the highest degree of safety while you sleep.

Tangram Shelf

Design Daniele Lago - 2002

UN GIOCO DIVENTATO LIBRERIA

La libreria Tangram si rifà a un antico gioco cinese composto da sette figure geometriche ricavate dalla scomposizione di un quadrato. L'oggetto è sempre lo stesso, un quadrato diviso in sette parti, ma le combinazioni sono infinite. Tangram è una libreria versatile dalle molteplici possibilità d'uso.

A GAME THAT BECAME A BOOKCASE

The Tangram bookshelf was inspired by the ancient Chinese game, comprising a single square cut into seven geometric shapes. The physical object always remains the same, a square divided into seven parts, but the combinations are infinite. Tangram is a versatile bookshelf with a world of possible uses.



Air Bed

Design Daniele Lago - 2007 / Patented Product



DORMIRE SOSPESI

Sospeso su lastre di vetro quasi invisibili, il letto Air sembra galleggiare nell'aria, portando una sensazione di leggerezza in camera da letto. Libero da vincoli a parete, è accessorabile con testiere e comodini che si agganciano su tutto il perimetro del telaio.

SLEEP IN THE AIR

Suspended on almost invisible sheets of glass, the Air bed seems to float in mid-air, bringing a feeling of lightness into the bedroom. Free of wall attachments, it can be accessorised with headboards and bedside tables that can be attached anywhere along the perimeter of the frame.





Air Wildwood Bed

Design Daniele Lago - 2007

UN LETTO CHE UNISCE LA TRASPARENZA DEL VETRO AL CALORE DEL LEGNO

In qualsiasi punto della testiera possono essere agganciati complementi rivestiti in tessuto che fungono da comodini e portaoggetti.

A BED THAT COMBINES THE TRANSPARENCY OF GLASS WITH THE WARMTH OF WOOD

Fabric-dressed accessories that can serve as side tables and object containers can be attached anywhere along the headboard.



Vele Bed

Design Andrea Leoni / LAGO Studio - 2014

TUTTO IN ORDINE E A PORTATA DI MANO

Tre pannelli, rivestiti in tessuto o pelle, costituiscono la testiera di un letto che integra il comodino nella testiera. Libri, tazze, cellulare, segreti d'amore: tutto è raggiungibile semplicemente allungando il braccio.

EVERYTHING IN PLACE AND EASY TO REACH

Three panels, covered in fabric or leather, form the headboard of a bed with bedside tables integrated into the headboard. Books, cups, cellphones and romantic secrets: everything within arm's reach.

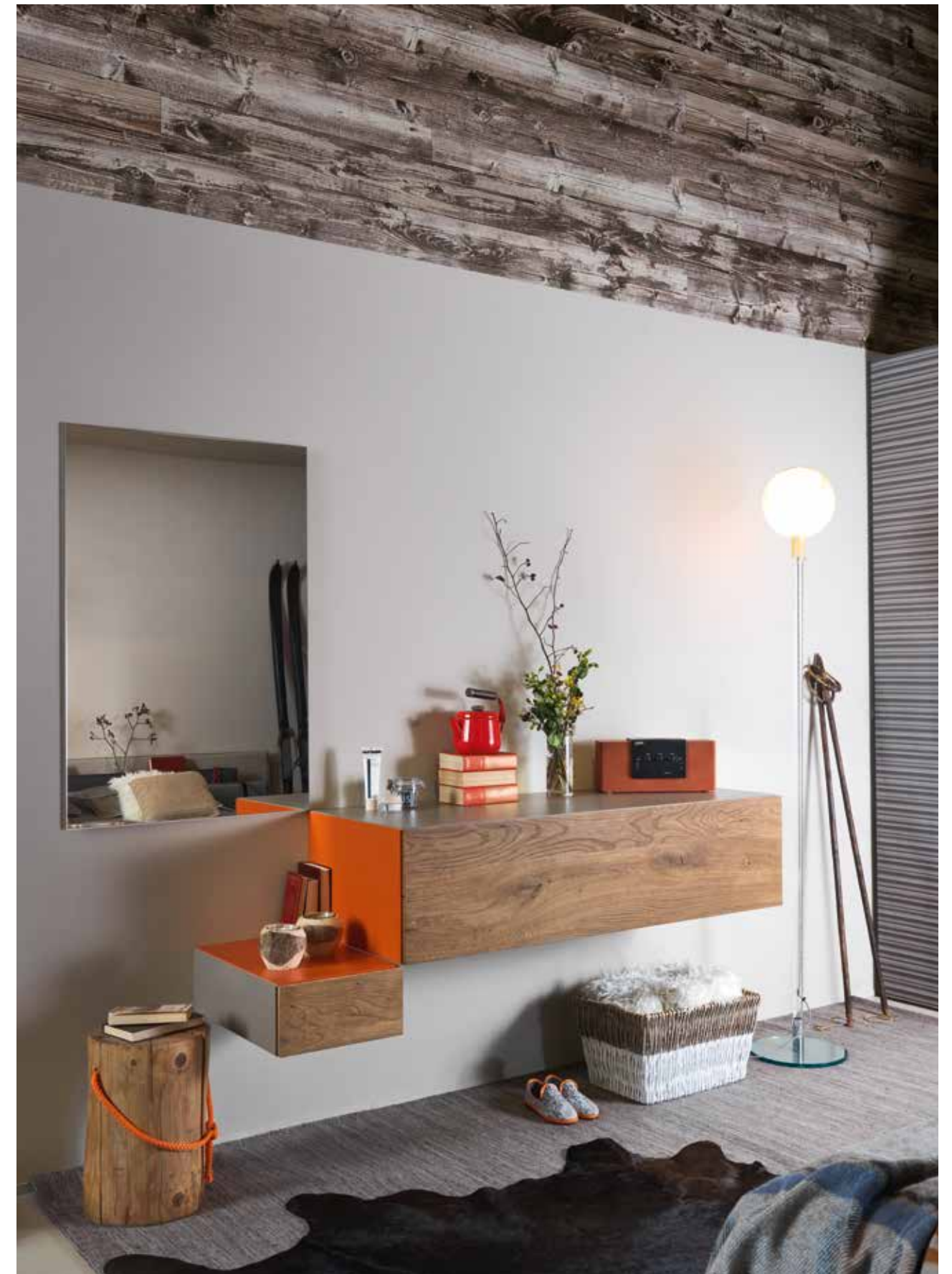



UN MONDO A MISURA DI BAMBINO

Per progettare questo ambiente non solo dal punto di vista funzionale, ma anche da quello educativo, abbiamo parlato e lavorato con bambini, adolescenti, genitori, educatori. Abbiamo raccolto le loro voci, i disegni, le parole, i sogni e li abbiamo trasformati in arredi.

A WORLD ON A CHILD'S SCALE

In order to design this room not just from the functional perspective but also from the enriching one, we talked with children, teenagers, parents and teachers. We gathered their ideas, drawings, words and dreams and transformed it all into furnishings.

KIDS & YOUNG

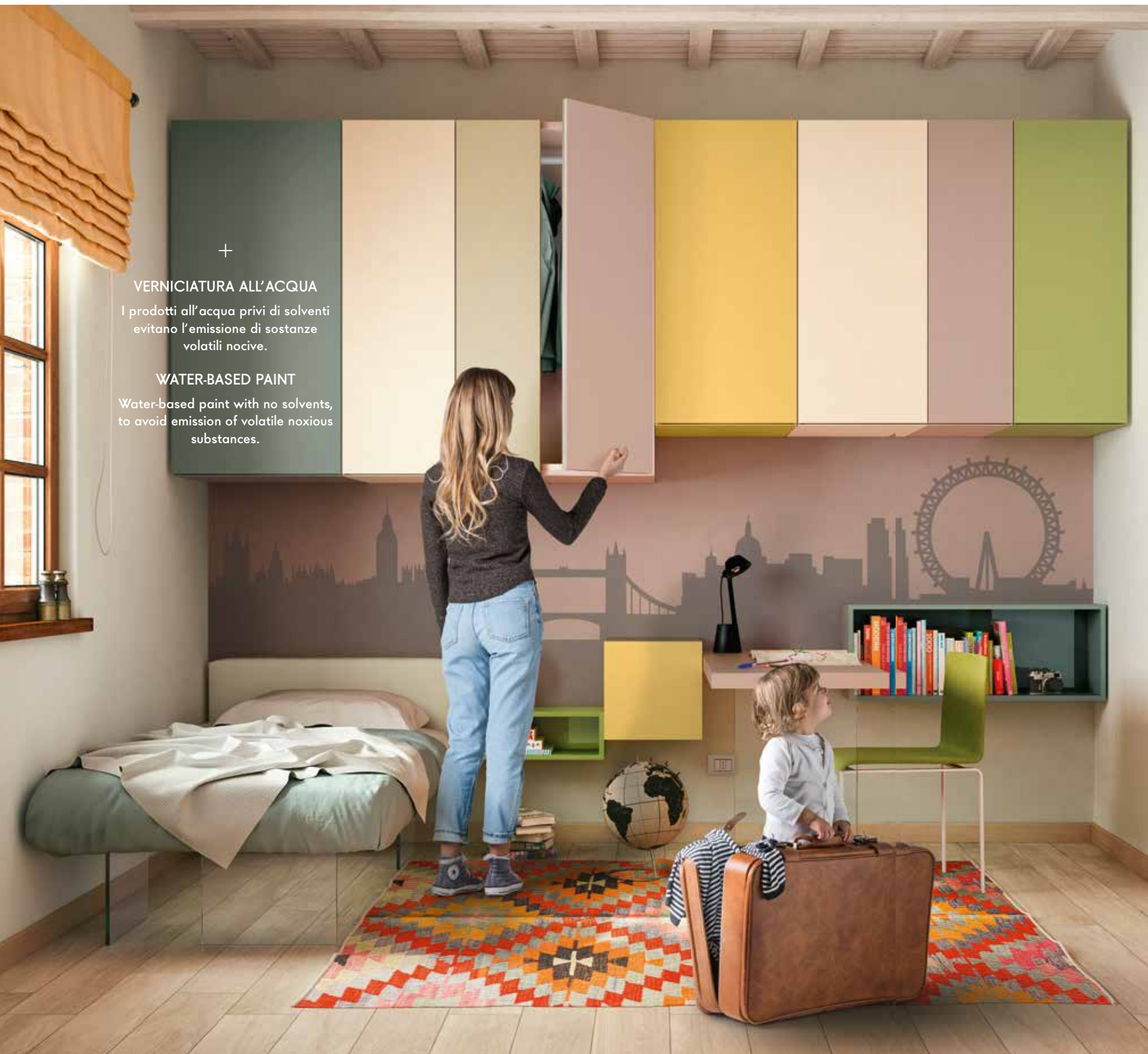

+

VERNICIATURA ALL'ACQUA

I prodotti all'acqua privi di solventi evitano l'emissione di sostanze volatili nocive.

WATER-BASED PAINT

Water-based paint with no solvents, to avoid emission of volatile noxious substances.

N.O.W. Smart Weightless Wardrobe

Design Daniele Lago

L'ARMADIO N.O.W. SOSPESO

La raffinata continuità tridimensionale della finitura sul fondo impreziosisce la sospensione, che avviene in totale sicurezza grazie ai doppi sistemi di fissaggio a parete. Una soluzione perfetta che offre contenimento sopra ad altri elementi quali letti e scrittoi.

THE SUSPENDED N.O.W.

The refined three-dimensional continuation of the finish on the bottom enhances the suspension, which is made fully safe by a dual wall attachment system. A perfect solution that creates storage above other furnishings, like beds and desks.

School Chair

Design Daniele Lago - 2011

DIETRO A OGNI OGGETTO C'È UNA STORIA

Una sedia che rievoca un classico dell'arredo scolastico viene reinterpretata in chiave moderna e impreziosita grazie al rivestimento in ecopelle colorato e a una sottile imbottitura, che aggiungono comfort e personalità. La struttura metallica garantisce massima resistenza.

THERE IS A STORY BEHIND EVERY OBJECT

A chair that conjures up and reinterprets the schoolroom classic, enhanced with a colourful eco-leather cover and subtle upholstery, adding comfort and character to the piece. The metal structure guarantees the highest level of durability.





LagoLinea Bed

Design Daniele Lago - 2014

UN'UNICA LINEA RACCHIUDE I SOGNI

Concepito per la camera dei ragazzi, il letto LagoLinea è disegnato da una linea che corre e ne crea la struttura. Nella versione Weightless è un nido in cui rifugiarsi e far volare la fantasia.

DREAMS EMBRACED BY A SINGLE LINE

Designed for kids' rooms, the LagoLinea bed comprises a single running line, which creates its structure. In the Weightless version, it becomes a nest where kids can escape and let their imaginations fly free.

LagoLinea è un segno grafico snello e leggero che trasforma la stanza con un semplice gesto: una linea disegna sulla parete animali, alberi, nuvole, stimolando la fantasia dei più piccoli.



LagoLinea is a sleek, light graphic mark that transforms rooms with a simple gesture, its line creating animals, trees, clouds and more on the wall, stimulating children's imagination.



Obeliscus Sofa

Design Luca Maria Arosio, Paolo Emanuele Nava / LAGO Studio - 2013

VERSO L'ALTO

Un solido a sezione rettangolare si innalza come una colonna, creando nuovi scenari abitativi e interagendo con i sistemi 36e8®, 30mm e LagoLinea. Perfetto se arrivano ospiti a casa e serve qualche posto più.

UPWARD BOUND

A rectangular piece rises like a column, creating new living scenarios and integrating with the 36e8®, 30mm and LagoLinea systems. Perfect for when guests arrive at home and you need some extra seating.



YOUNG&DESIGN AWARD HONOURABLE MENTION AWARD 2013



Cloud Bed

Design Daniele Lago - 2015

UN NIDO SOSPESO FRA LE NUVOLE

Cloud Bed è un letto sospeso, progettato per infondere un senso di intimità e protezione nel bambino. È un nido sospeso fra le nuvole, in cui i più piccoli possono rifugiarsi a leggere, giocare o rilassarsi in una dimensione ovattata. Essenziale nella linea, ha un attacco a parete estremamente solido ed è testato secondo normativa europea.

A SUSPENDED NEST UP IN THE CLOUDS

Cloud Bed is a suspended bed designed to create a sense of intimacy and make children feel sheltered. It is a nest suspended among the clouds, where little ones can go to read, play or relax in a soft, cosy dimension. Designed with a minimal line, it is equipped with an extremely solid wall attachment and has been tested according to European regulations.



EMOZIONE E SORPRESA PER IL CORPO E PER LA MENTE

Calore, accoglienza, una visione coordinata degli accessori e l'impronta sorprendente del sistema LAGO trasformano il bagno in un'esperienza di quotidiana soddisfazione.

EMOTION AND SURPRISE FILL THE BATHROOM WITH SOUL

Warmth, surprise, coordinated accessories and the wonder of LAGO systems transform the bathroom into a site of everyday joy.

BATHROOM



LAGO.IT

Scopri tutte le soluzioni per lo spazio del tuo benessere su [lago.it/design/bagno](https://www.lago.it/design/bagno)

Discover all of the possibilities for your wellness area at [lago.it/en/design/bathroom](https://www.lago.it/en/design/bathroom)

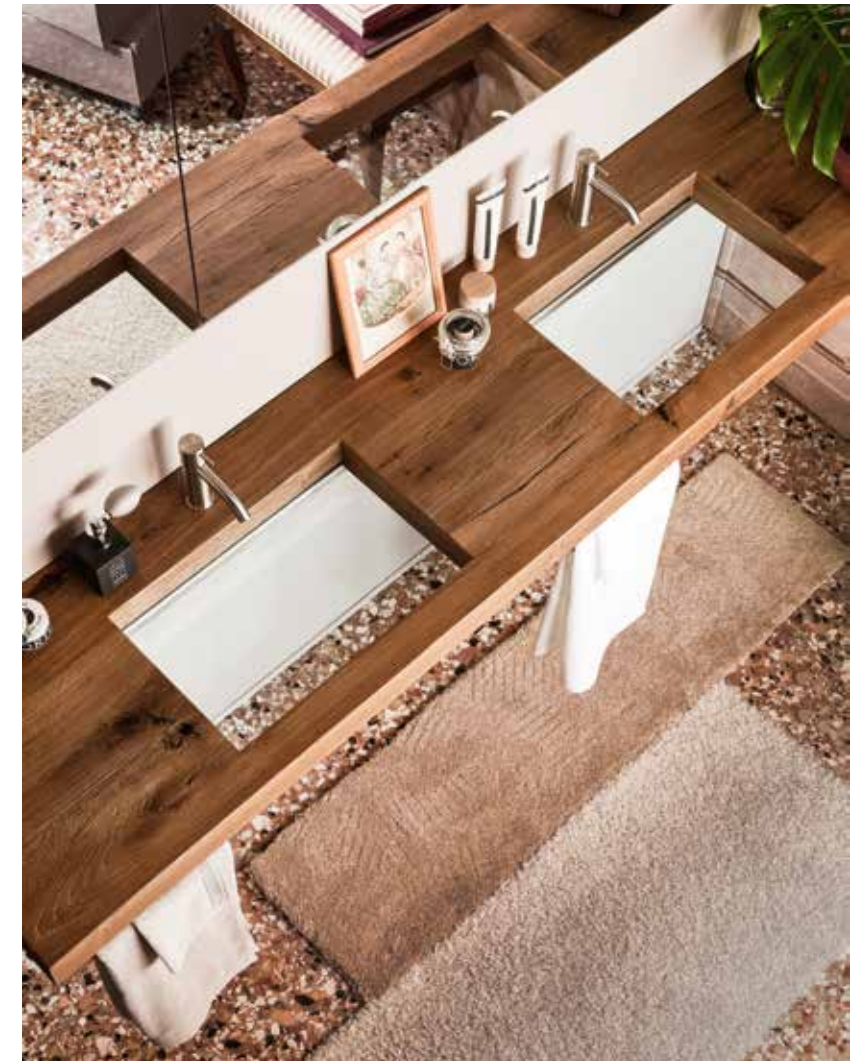

Depth Basin

Design Daniele Lago - 2013

UNA FINESTRA SULLA TERRA, UNA FINESTRA SULL'ACQUA

Risultato di una sottrazione di volume da una mensola di 8 cm di spessore, Depth è un lavabo che gioca con il senso del vuoto e della profondità. Finiture disponibili: Wildwood, resina, laminato. La versione con doppio lavabo aumenta lo spazio per l'appoggio e aggiunge calore all'ambiente.

A WINDOW ON THE EARTH, A WINDOW ON WATER

The result of a subtraction of volumes from an 8-cm-thick shelf, Depth is a washbasin that plays with our sense of void and depth. Available finishes: Wildwood, resin, laminate. The version with two sinks increases the usable surface space and adds warmth to the room.



36e8® Basin

Design Daniele Lago - 2013

UNA PICCOLA GOCCIA D'ACQUA. UNA GRANDE GOCCIA DI VETRO

Un termotrattamento del top in vetro disegna un sinuoso e pratico lavabo integrato alle basi 36e8®, che consente un contenimento versatile per progettare il proprio spazio con varie finiture e dimensioni.

A SMALL DROP OF WATER. A BIG DROP OF GLASS

The heat-treated glass top creates a sinuous, practical basin, integrated into the 36e8® bases, offering versatile storage options for designing your space with varied finishes and dimensions.



Inbilico Basin

Design Andrea Leoni / LAGO Studio - 2014

L'ORDINE E IL CAOS SEGUONO LA TUA INCLINAZIONE

Un lavabo in ceramica che sfida il senso dell'equilibrio. L'orientamento può essere deciso in fase di installazione, a seconda delle esigenze estetiche o ergonomiche.

ORDER AND CHAOS FOLLOW YOUR OWN INCLINATION

A ceramic washbasin that challenges your sense of balance. You can choose the orientation when you install it, based on aesthetic and ergonomic needs.





Skin Basin

Design Daniele Lago - 2013 / Patented Product

LA "PELLE" DEL RIVESTIMENTO SI SOLLEVA PER TE

La superficie di rivestimento del muro sembra staccarsi, originando un sottile lavabo supportato da una solida struttura in acciaio e rivestibile in resina o con tessere di mosaico da 1 x 1cm.

THE "SKIN" OF THE SURFACE RAISES UP FOR YOU

The wall covering detaches from the surface like a skin. The core is a solid steel structure that can be covered with 1x1 cm mosaic or resin.



Cellule Basin

Design Daniele Lago - 2013

LA PERFEZIONE DEL CERCHIO. NIENTE DI PIÙ. TANTO CON POCO

Un lavabo circolare a parete in Cristalplant®, laccato esternamente, attorno a cui sono posizionabili, come piccole cellule, vassoi in legno Wildwood oppure in vetro colorato e portasciugamani in metallo.

THE PERFECTION OF THE CIRCLE. NOTHING MORE. SO MUCH FROM SO LITTLE

A circular, wall-mounted basin in Cristalplant® with a lacquered exterior that you can accessorise with cell-like wooden Wildwood or colourful glass trays and metal towel holders.



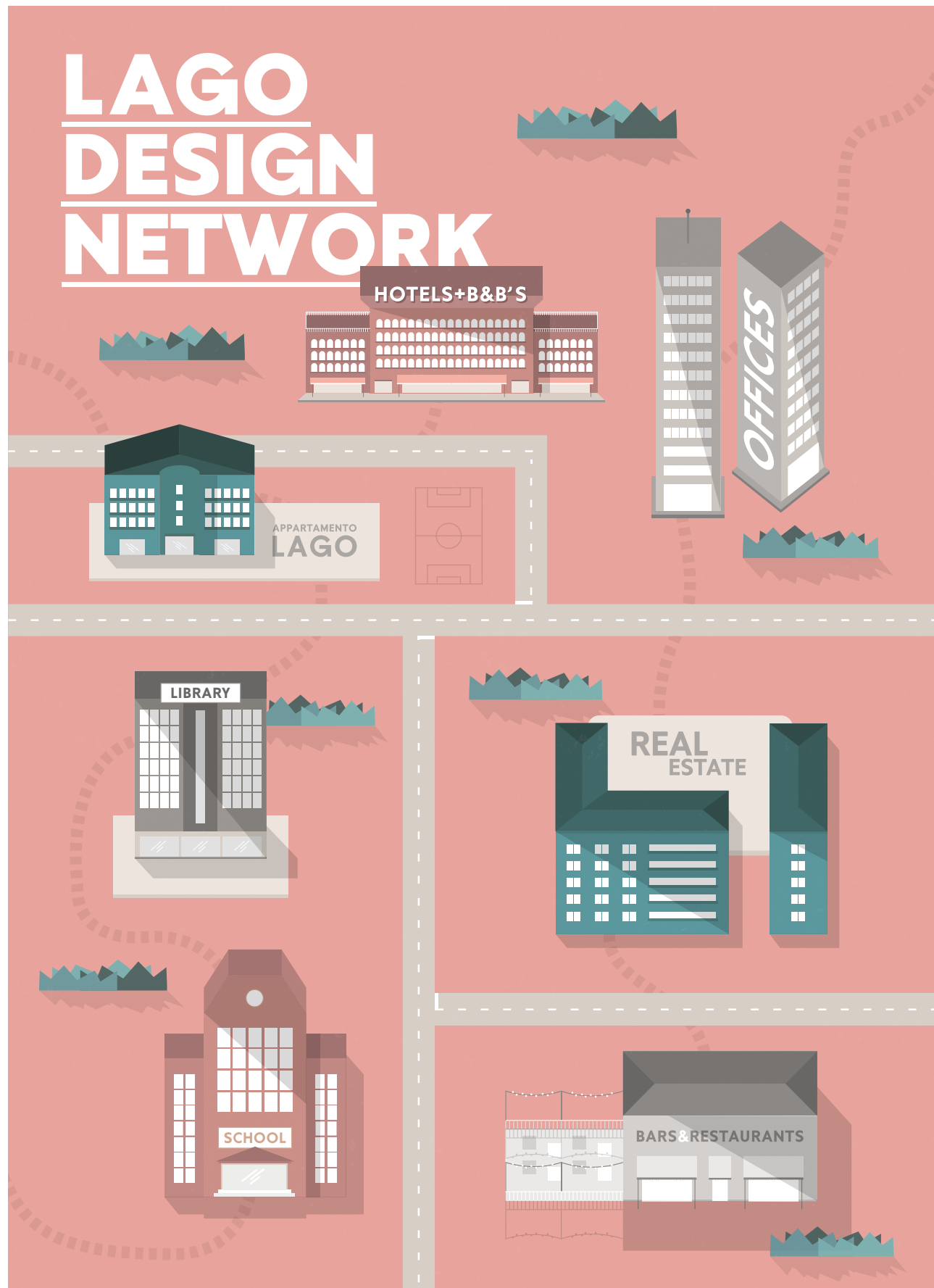

IL DESIGN MIGLIORA IL TUO BUSINESS

LAGO DESIGN NETWORK è una visione d'insieme che guarda al design come attivatore di connessioni e risorsa culturale portatrice di significato. Si tratta di una rete di persone e luoghi diffusi sul territorio, che comprende negozi e abitazioni, uffici e musei, ristoranti e alberghi. Grazie a un potente motore di comunicazione digitale connettiamo ogni luogo e ogni spazio di questo nuovo, grande Network, dove ogni membro è protagonista attivo e può beneficiare di inedite opportunità di business e di nuove connessioni umane.

Scopri i luoghi del LAGO DESIGN NETWORK:

LAGO AT WORK - Nell'ufficio del futuro ci si sente come a casa e si lavora meglio.

LAGO WELCOME - Hotel, B&B e Resort dove la cura del design è accoglienza.

LAGO REAL ESTATE - Far sognare ad occhi aperti la casa di domani.

LAGO INSIDE - Il design migliora il tuo business in tutti gli spazi dove scorre la vita.

APPARTAMENTO LAGO - La casa diventa uno showroom aperto al mondo.

DESIGN IMPROVES YOUR BUSINESS

The **LAGO DESIGN NETWORK** is an all-encompassing vision that sees design as an activator of connections and a meaningful cultural resource. It is a wide-ranging network of people and places that includes stores, homes, offices, museums, restaurants and hotels. Thanks to our powerful digital communication engine, we connect every space and every place in this big new Network, where every member is an active protagonist and can benefit from new human connections and fresh business opportunities.

Discover the locations in the LAGO DESIGN NETWORK:

LAGO AT WORK - The office of the future, where you feel at home and work more effectively.

LAGO WELCOME - Hotels, B&B and Resorts where the attention lavished on design extends to hospitality.

LAGO REAL ESTATE - Dreaming up the house of tomorrow with your eyes wide open.

LAGO INSIDE - Design can improve your business in all of the places where life unfolds.

APPARTAMENTO LAGO - The home as a showroom open to the world.

TECHNICAL DETAILS

36E8®_STORAGE



Contenitori struttura laccato o Wildwood
Frontali laccato, vetro lucido, vetro opaco, Wildwood.

Lacquered or Wildwood storage unit structure.
Lacquered, polished glass, matt glass, Wildwood fronts.

Apertura vastistas Apertura vastistas

	↓ (cm)	↔ (cm)	↗ (cm)
	18,4	36,8	27,0
	36,8	55,2	40,6
		73,6	
		92,0	
		110,4	
		147,2	
		184,0	
		220,8	

Apertura ribalta Bottom-hung door opening

	↓ (cm)	↔ (cm)	↗ (cm)
	18,4	36,8	27,0
	36,8	55,2	40,6
		73,6	56,0
		92,0*	
		110,4	
		147,2	
		184,0	
		220,8*	

* Per profondità 27,0 e 40,6
* For depth 27,0 and 40,6

Cestoni o cassetti Deep drawers or drawers

	↓ (cm)	↔ (cm)	↗ (cm)
	18,4	36,8	40,6
	36,8	55,2	50,6
		55,2*	73,6
		73,6*	110,4
		110,4*	147,2
		184,0	

* Larghezza max 110,4
* Max width 110,4

Anta battente Hinged door

	↓ (cm)	↔ (cm)	↗ (cm)
	36,8	36,8	27,0
	55,2	55,2	40,6
		73,6	56,0
		92,0*	110,4**
		110,4*	147,2**
		147,2*	184,0**
		184,2*	
		220,8*	

* Per profondità 27,0 e 40,6
** Per profondità 56,0
* For depth 27,0 and 40,6
** For depth 56,0

Contenitori a giorno Open storage unit

	↓ (cm)	↔ (cm)	↗ (cm)
	18,4	36,8	27,0
	36,8	55,2	40,6
		73,6	
		110,4	
		147,2	
		184,0	
		220,8*	

* Per altezza 36,8
* For height 36,8

	↓ (cm)	↔ (cm)	↗ (cm)
	73,6	36,8	27,0
	92,0*	73,6	40,6
	110,4		
	147,2		
	184,0		
	220,8		

* Per altezza 36,8
* For height 36,8

36e8 Glass

	↓ (cm)	↔ (cm)	↗ (cm)
	36,8	36,8	24,8
		55,2	
		73,6	
		92,0	
		110,4	
		147,2	

LAGOLINEA_SHELF/30MM_SHELF



Fianchi laccato sp. 3-5 cm P. 13,6-24,8-38,4 Lacquered sides th. 3-5 cm D 13,6-24,8-38,4

	(cm)	(cm)	(cm)	(cm)
↔	3	3	3	5
	18,4	18,4	18,4	36,8
	36,8	36,8	36,8	73,6
	55,2	55,2	55,2	110,4
	73,6	73,6	73,6	147,2
	92,0	92,0	92,0	184,0
↓	110,4	110,4	110,4	220,8
	147,2	147,2		257,6
	184,0	184,0		
	220,8	220,8		
	257,6	257,6		
	294,4	294,4		
↗	13,6	24,8	38,4	38,4

Ripiani laccato sp. 3-5 cm P. 13,6-24,8-38,4 Lacquered shelves th. 3-5 cm D 13,6-24,8-38,4

	(cm)	(cm)	(cm)	(cm)
↓	3	3	3	5
	18,4	18,4	18,4	36,8
	36,8	36,8	36,8	73,6
	55,2	55,2	55,2	110,4
	73,6	73,6	73,6	147,2
	92,0	92,0	92,0	184,0
↔	110,4	110,4	110,4	220,8
	147,2	147,2		257,6
	184,0	184,0		
	220,8	220,8		
	257,6	257,6		
	294,4	294,4		
↗	13,6	24,8	38,4	38,4

Schienali laccato (sp.1,9), vetro lucido o specchio (sp. 2), tessuto Stratus (sp. 2,2) Lacquered backs (th.1,9), polished glass (th.2), Stratus fabric (th.2,2)

	(cm)	(cm)	(cm)	(cm)	(cm)	(cm)
↔	36,8	73,6	110,4	147,2	184	220,8
	36,8	36,8	36,8	36,8	36,8	36,8
	73,6	73,6	73,6	73,6	73,6	73,6
↓	110,4	110,4	110,4	110,4	110,4	110,4
	184,0	184,0	184,0			
	257,6	257,6				



LAGO.IT

Scopri come il design può cambiare il tuo business su lago.it/progetti e chatta con un interior designer LAGO.

Discover how design can help your business, visit lago.it/en/projects and chat with a LAGO interior designer.

DIAGOLINEA_SHELF



Mensola laccata con un supporto (sp. 3 cm)
Lacquered shelf with 1 support (th. 3 cm)

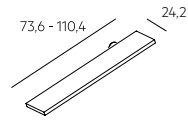

30MM WEIGHTLESS_SHELF



Fianchi laccato con staffa per fissaggio
a soffitto P 24,8-38,4 / Lacquered sides
with bracket for ceiling fixing D 24,8-38,4

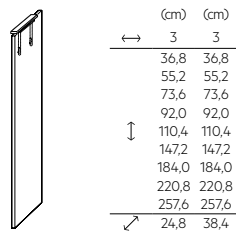

Ripiani laccato
Lacquered shelves

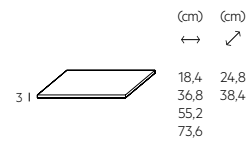

Schienale in vetro trasparente
Clear glass backs

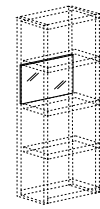

Schienali bifacciali
Finitura in laccato, vetro lucido o vetro opaco
Two-sided backs
Lacquered, polished glass or matt glass finish

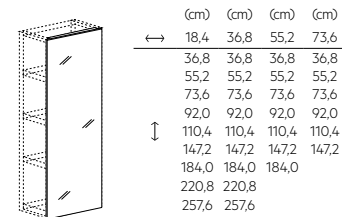

ET VOILÀ_STORAGE



Frontale in tessuto
Lago Tailoring: Stratus, Incertum, Organicum, Alveare
Fabric front
Lago Tailoring: Stratus, Incertum, Organicum, Alveare

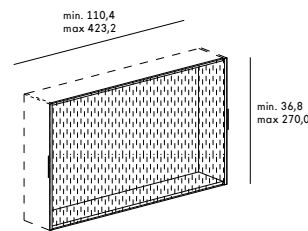

Il frontale in tessuto si applica a composizioni LagoLinea/30mm
The fabric front applies to LagoLinea/30mm compositions

Ecco alcuni esempi:/See some examples:

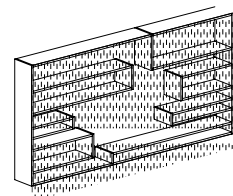

Configurazione con fianchi e ripiani interni /
Configuration with internal sides and shelves

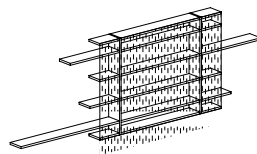

Configurazione con ripiani terminali e
fianchi "rientranti" / Configuration with
endshelves and internal sides

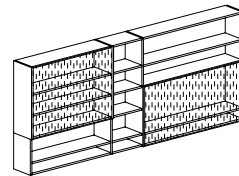

Configurazione con colonne a giorno
sopra/sotto o a fianco al volume chiuso /
Configuration with open columns above/
below or next to the closed volume

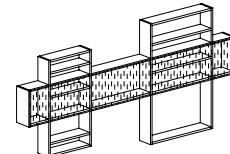

Configurazione con colonne a giorno
che "attraversano" il volume chiuso /
Configuration with open columns crossing
the closed volume

AIR_STORAGE & SHELF



Mensole-Finitura laccato /Shelves-Lacquered finish

Fondo - Mensola - Top - Finitura laccato o Wildwood
Base - Shelf - Top - Lacquered or Wildwood finish

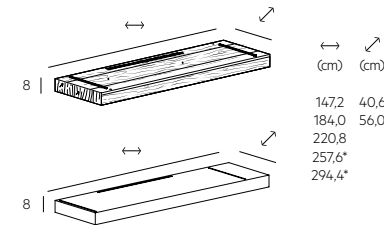

* Solo per fondo in Wildwood
*Only for Wildwood base

Fondo - Mensola - Top - Finitura laccato e Rovere gentile
Fondo - Mensola - Top - Lacquered or gentle oak finish

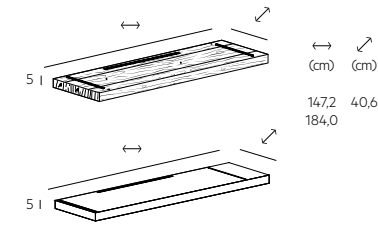

Set vetri a terra per fondo in Wildwood
Floor glass set for Wildwood base

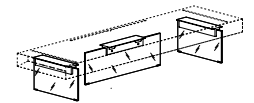

Ribalta / Bottom hung opening

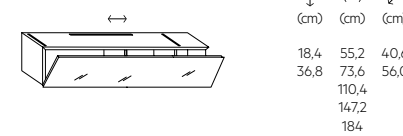

Set vetri / Glass set

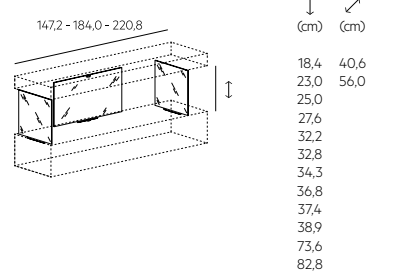

Vasistas / Top hung opening

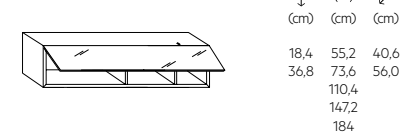

Set vetri a terra per contenitori
Floor glass set for units only

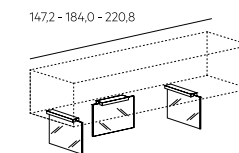

NET_STORAGE



Contenitori con frontale laccato o vetro lucido
Storage units with lacquered or polished glass fronts

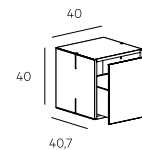
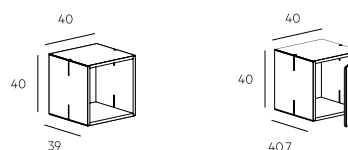

Contenitori in vetro trasparente
Clear glass storage units

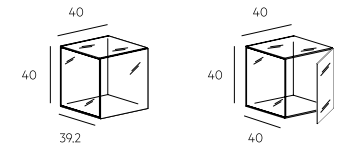

AIR_SOFA



Rivestimenti / Coverings:
 Cotone ecologico / Ecological cotton
 Cotone naturale / Natural cotton
 Lino Canovaccio / Canovaccio linen
 Rico / Rico
 Capri / Capri
 Francis / Francis
 Remix / Remix
 Ecopelle / Eco-leather
 Pelle / Leather
 Sun / Sun

Sedute / Seats

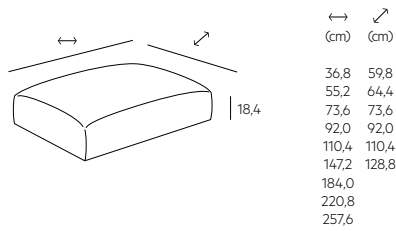

Penisole / Peninsulas

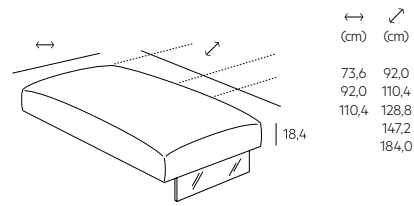

Schienali-Braccioli / Backrests-Arms

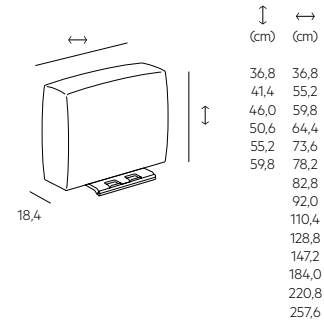

Telaio / Frame

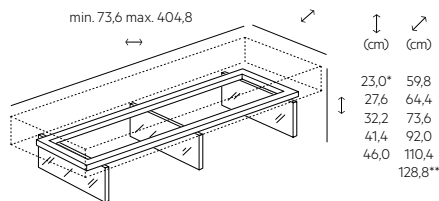

Schienali Wildwood / Wildwood backrests

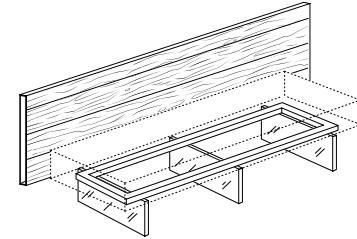

SLIDE_SOFA



Rivestimenti / Coverings:
 Cotone ecologico / Ecological cotton
 Cotone naturale / Natural cotton
 Lino Canovaccio / Canovaccio linen
 Rico / Rico
 Capri / Capri
 Francis / Francis
 Remix / Remix
 Ecopelle / Eco-leather
 Pelle / Leather
 Sun / Sun

Moduli schienali / Back modules

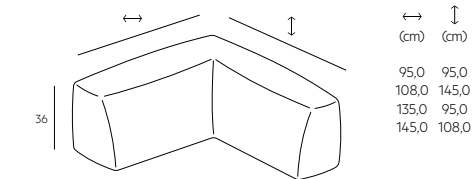
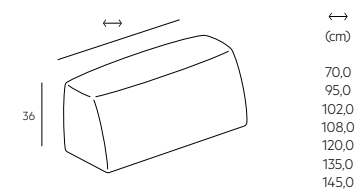

Sedute / Seats

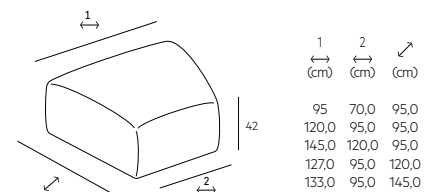

CHAMA_ARMCHAIR



Rivestimenti / Coverings:
 Cotone ecologico / Ecological cotton
 Cotone naturale / Natural cotton
 Lino Canovaccio / Canovaccio linen
 Rico / Rico
 Capri / Capri
 Francis / Francis
 Remix / Remix
 Ecopelle / Eco-leather

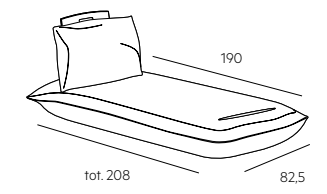
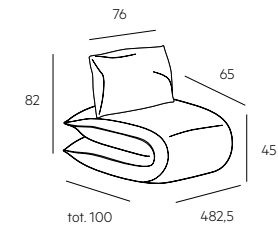

CHAMA_SOFA



Rivestimenti / Coverings:
 Cotone ecologico / Ecological cotton
 Cotone naturale / Natural cotton
 Lino Canovaccio / Canovaccio linen
 Rico / Rico
 Capri / Capri
 Francis / Francis
 Remix / Remix
 Ecopelle / Eco-leather

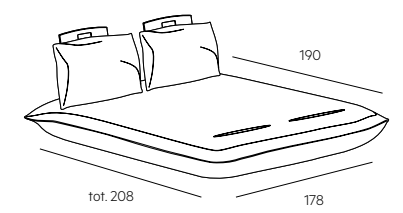
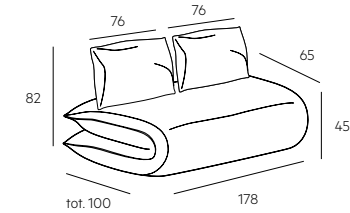

HUGGY_ARMCHAIR



Base laccato / Lacquered base:
 bianco, sole, grafite, nero, rosso

Rivestimenti: tessuto Righe,
 patchwork, tessuti Lago.
 Coverings: striped fabric,
 patchwork fabric, Lago fabrics

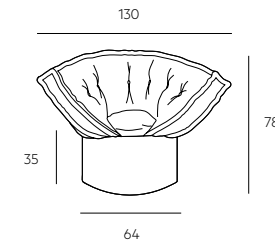

OBELISCUS_SOFA



Rivestimenti
 Stretch - sfoderabile
 ecopelle - sfoderabile

Coverings:
 Stretch - removable
 Eco-leather - removable

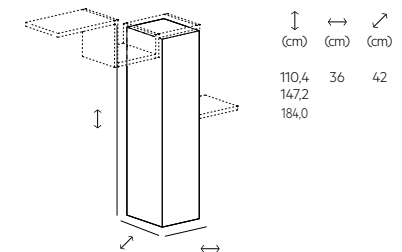

LASTIKA_ARMCHAIR



Seduta con nastri elastici. Struttura
 bianco o nero.

Seat with elastic bands. Black or
 white structure.

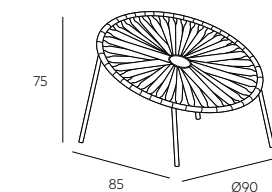

AIR_TABLE



Tavolo in Wildwood
Wildwood table

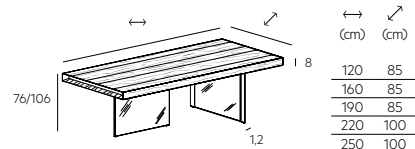

Tavolo in laminato, laccato, quarzo
Laminated, lacquered, quartz table

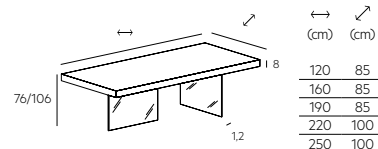

Tavolo Madeterraneo
Madeterraneo table

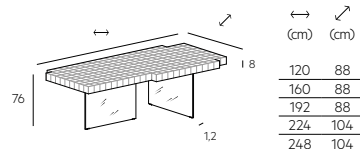

Tavolo in vetro
Glass table

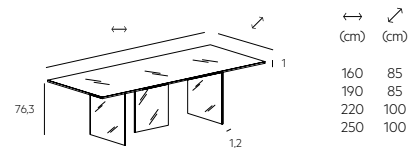

Tavolo in vetro laccato
Lacquered glass table

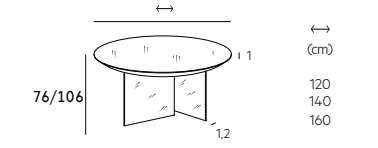

Tavolo in Wildwood
Wildwood table

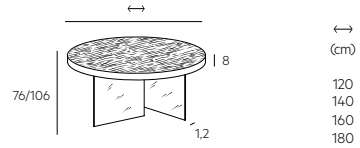

AIR_TABLE ALLUNGABILE / EXTENSIBLE

Top laccato o Wildwood. Prolunghe laccate o Wildwood
Wildwood or lacquered top. Wildwood or lacquered extensions

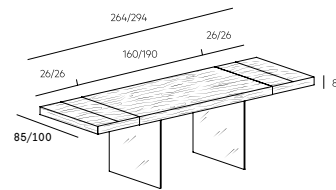

AIR_COFFEE TABLE

Tavolini a Doghe H 28,0 / 41,4 - Finitura laccato
Small slatted tables H 28-41,4 - Lacquered finish

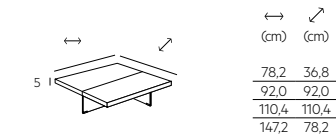

Tavolini Air in Wildwood - H 31,0 - 44,4
Wildwood Air small table - H 31,0 - 44,4

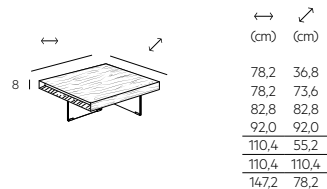

Tavolini Madeterraneo H31,0 / 44,4
Madeterraneo coffee tables H31,0 / 44,4

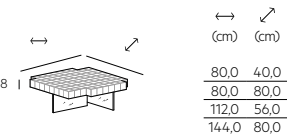

Tavolini - Top laccato
Small tables - Lacquered finish

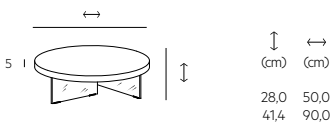

Tavolini - Top Wildwood
Small tables - Wildwood Top

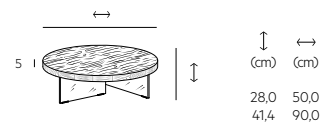

Tavolini - Top vetro
Small tables - Glass top

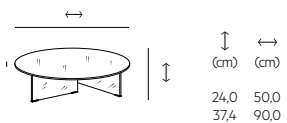

VERTIGO_TABLE

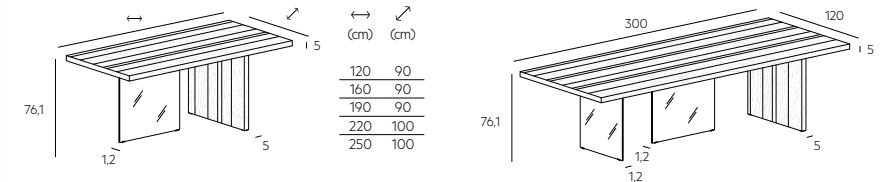

Rovere laccato poro aperto, colori: nero, grafite, bianco, amaranto, ottanio
Open-pore lacquered oak, in colours: nero, grafite, bianco, amaranto, ottanio

LOTO_TABLE



Tavolo con prolunghe
Table with extensions

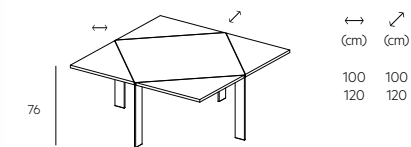

Tavolo senza prolunghe
Table without extensions

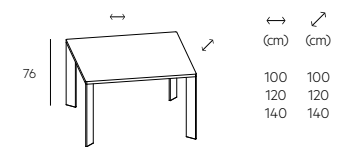

Top laccato o Wildwood. Gambe laccate. / Wildwood or lacquered top. Lacquered legs

AXYS_TABLE



Design ruotato
Rotated design

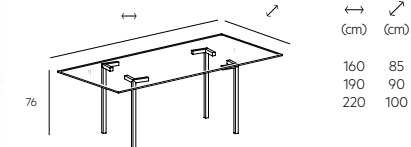

Design parallelo
Parallel design

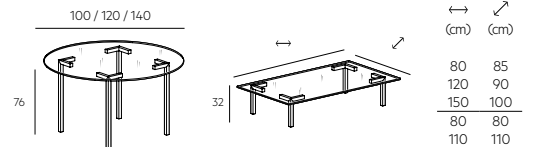

Top vetro trasparente, gambe laccate / Transparent glass top, lacquered legs

COMFORT TABLE

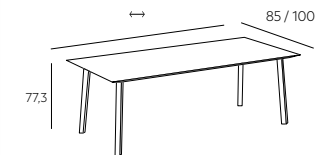

Top laccato, Gambe in rovere / Lacquered top, oak legs

KINOKI_TABLE

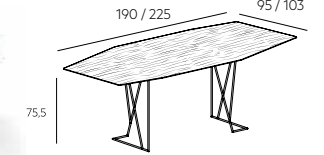
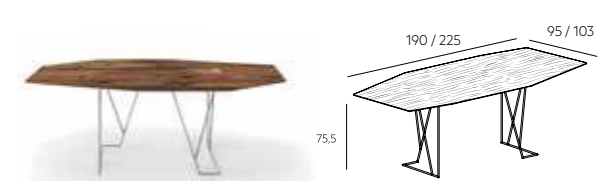

Top Wildwood, Struttura verniciata bianco o grafite / Wildwood top, structure painted in white or graphite

SOFT BENCH

AIR WILDWOOD_BENCH

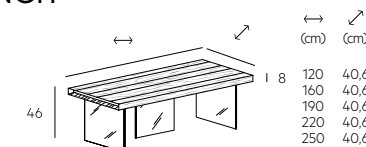

Panca H 46 / Bench H 46

Seduta Wildwood, gambe vetro trasparente / Wildwood seat, transparent glass legs



Panca /Bench

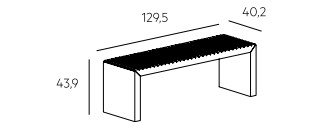

Finitura laccato / Lacquered finish

DANGLA_CHAIR

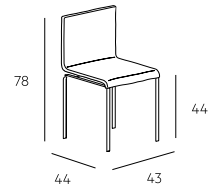

Rivestimento: liscio, zip o arricciato in cotone ecologico, ecopelle, pelle. Struttura bianco, nero, grafite / Covering: plain, zip, wrinkled in ecological cotton, eco-leather, leather. White, black or graphite structure.

PLETRA_CHAIR

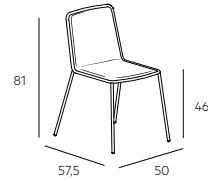

Rivestimento: tessuti Lago. Struttura bianco, nero, cromato nero. / Covering: Lago fabrics.. White, black or black chrome plated steel structure

TAPPETI / RUGS



FLAT: 100% poliammide 6,6, accoppiato con feltro sintetico di supporto. Spessore 1,7 cm, texture rasa in 5 colori / FLAT: 100% polypropylene, coupled with synthetic felt support. 1.7 cm thick, smooth texture in 5 colours

CURLY: 100% poliammide 6,6, accoppiato con feltro sintetico di supporto. Spessore 1,9 cm, texture tipo ricciolo in 5 colori / CURLY: 100% polyamide 6,6, coupled with support synthetic felt. 1.9 cm thick, curly texture in 5 colours

LIFT_CHAIR

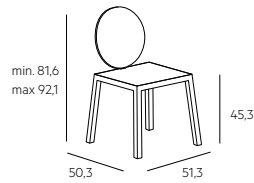

Schienale rivestito tessuti Lago. Struttura colore nero. Lago fabrics coated back. Black structure.

SCHOOL_CHAIR

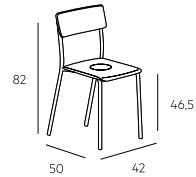

Struttura bianco o nero, seduta e schienale rivestiti in ecopelle. / White or black structure, seat and backs coated with eco-leather

36E8®_RUG

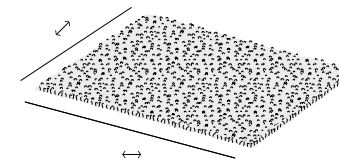

	(cm)	(cm)	(cm)	(cm)	(cm)	(cm)	(cm)
↔	3,61	10,4	14,72	18,4	220,8	57,6	294,4
	36,8	18,41	18,41	18,41	18,41	18,41	18,41
	55,2	36,8	36,8	36,8	36,8	36,8	36,8
↗	73,6	55,2	55,2	55,2	55,2	55,2	55,2
	73,6	73,6	73,6	73,6	73,6	73,6	73,6
	110,4	110,4	110,4	110,4	110,4	110,4	110,4

JOYNT_CHAIR

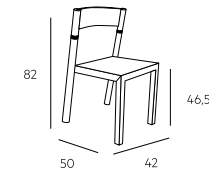

Seduta in rovere schienale laccato
Chair in oak with lacquered back

SLIDE_RUG

Modulo 1
Module 1

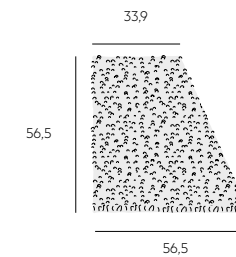

Modulo 2
Module 2

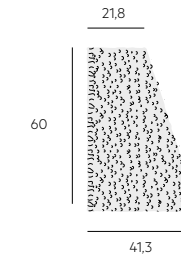

Modulo 3
Module 3

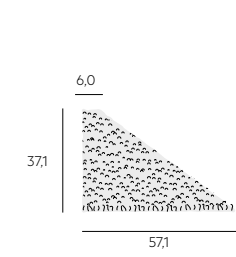

STEPS_CHAIR

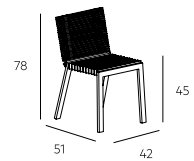

Feltro nero o grafite. Struttura nero o grafite
Black or graphite felt. Black or graphite structure.

STEPS_STOOL

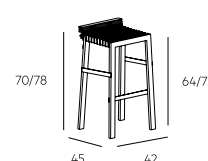

PLET_RUG

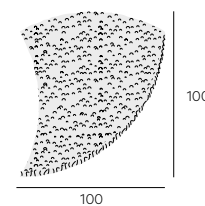

KINOKI_CHAIR

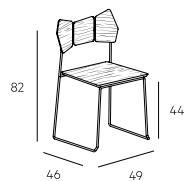

Struttura: verniciata bianco o grafite. Seduta e schienale: Wildwood / Structure: painted in white or graphite. Seat and backs: Wildwood

KINOKI_STOOL

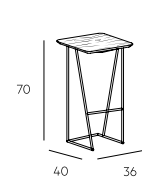

36E8®_KITCHEN



Contenitori struttura laccato fianchi di finitura laccato, Wildwood, vetro lucido, vetro opaco.
Frontali laccato, vetro laccato, vetro opaco, Wildwood.

Storage units with lacquered structure and sides in lacquered, Wildwood, polished or matt glass.
Lacquered, lacquered glass, matt glass, Wildwood fronts

Basi P 52 - 61 - 67 cm - Frontali in vetro lucido, vetro opaco, Wildwood. Basi P 53,2 - 62,2 - 98,2 - Frontali laccati.
Base units P 52 - 61 - 67 cm - Polished glass, matt glass, Wildwood fronts. Base units P 53,2 - 62,2 - 98,2 - Lacquered fronts.

Larghezze disponibili: 36,8 - 55,2 - 73,6 - 92 - 110,4
Available widths: 36,8 - 55,2 - 73,6 - 92 - 110,4

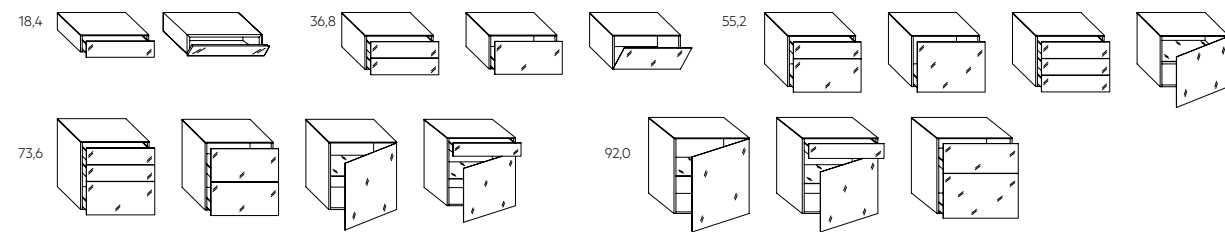
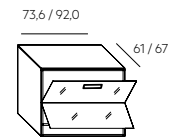
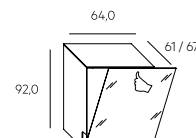
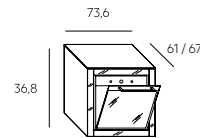
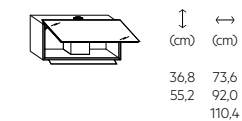
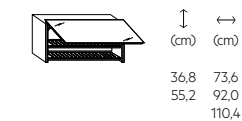
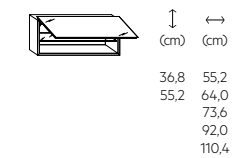
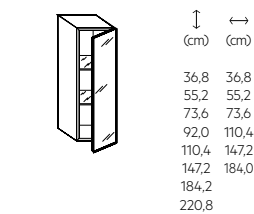
Lavastoviglie sospesa
Wall-hung dishwasherLavastoviglie standard
Standard dishwasherForni
OvensCappa P 40,6 cm
Hood D 40,6 cmScolapiatti P 40,6 cm
Dish Drainer D 40,6 cmApertura vasistas P 40,6 cm
Top-hung door opening D 40,6 cmAnta battente P 27-40,6 cm
Hinged door D 27-40,6 cm

Contenitori a giorno/ Open storage unit

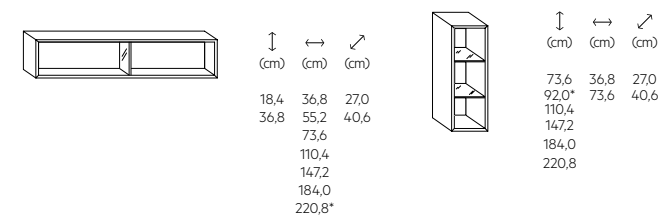

* Per altezza 36,8
* For height 36,8

* Per larghezza 36,8
* For width 36,8

36e8 Glass

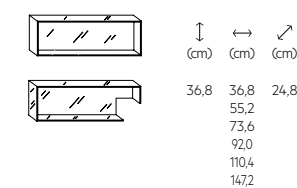

Penisola sp. 8 cm / Peninsula th. 8 cm

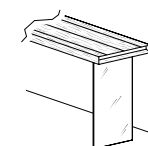
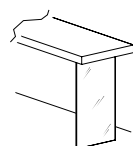
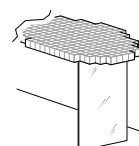
Top Wildwood
Wildwood topTop acciaio
Steel topTop Maderraneo
Maderraneo top

Air Kitchen

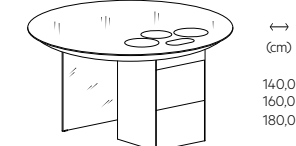
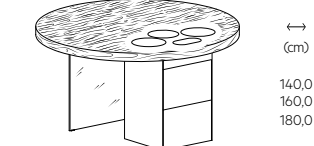
Top vetro
Glass topTop Wildwood
Wildwood top

N.O.W._LARDER



Ante vetro.
Frontali vetro lucido, vetro opaco.
Glass doors.
Polished or matt glass fronts

Frigo / Fridge

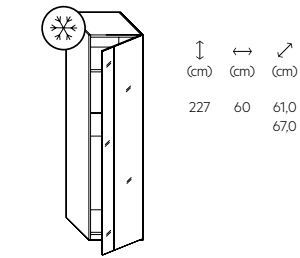

Forno / Oven

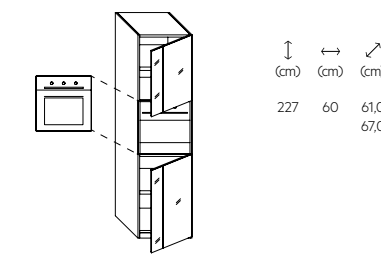

Colonne battenti / Hinged columns

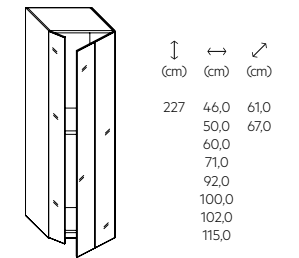

Larghezza totale composizione da verificare con spessore fianchi esterni. / Final composition width to be checked counting external sides thickness

Ante Smart.
Frontali laccati.
Smart doors.
Lacquered fronts.

Frigo - Ante Smart / Fridge - Smart doors

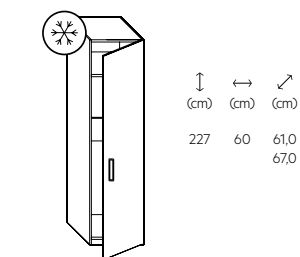

Forno - Ante Smart / Oven - Smart doors

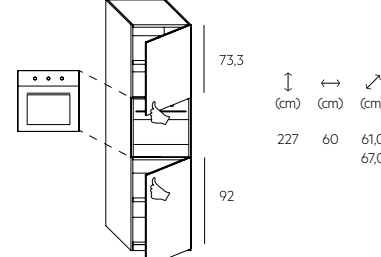

Colonne battenti - Ante Smart / Hinged columns - Smart doors

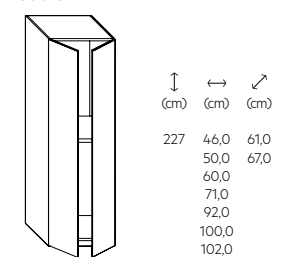

Larghezza totale composizione da verificare con spessore fianchi esterni.
Final composition width to be checked counting external sides thickness

36E8 COLUMN_LARDER



Frontali vetro lucido, vetro opaco.
Polished or matt glass fronts.

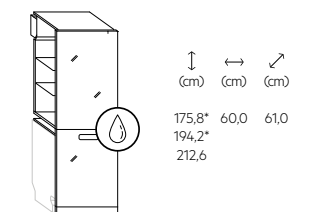
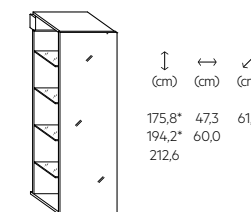
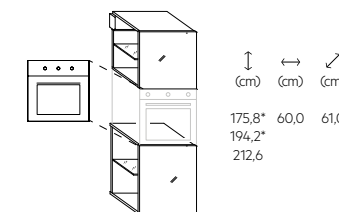
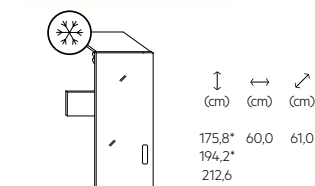

A terra o sospese.
Standing on the floor or suspended.

FLUTTUA R_BED



Pianale rete con struttura
Slat board with structure

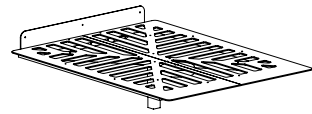

Materasso
Mattress
(cm)

100x200
120x200
150x200
152x203
160x200
180x200
193x203

Testiera sp. 5 cm - Rivestimenti Tessuti Lago
Headboard th. 5cm - Coverings in Lago fabrics

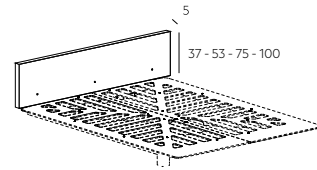

Testiera Wildwood sp. 9,6 cm
Wildwood Headboard th. 9,6 cm

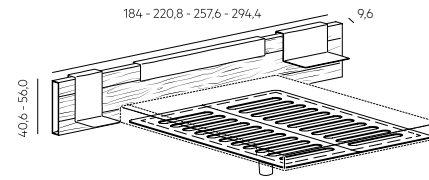

Materasso
Mattress
(cm)

150x200
160x200
180x200

FLUTTUA C_BED

Pianale rete con struttura
Slat board with structure

A1 Pianale
A2 Materasso
A1 Platform
A2 Mattress

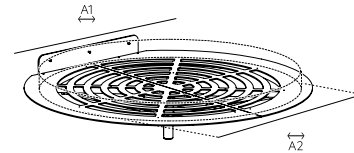

A1	A2
(cm)	(cm)
234	218
234x218	240x220
240	220

Testiera Sp. 5cm - Rivestimenti Tessuti Lago
Headboard th. 5cm - Coverings in Lago fabrics

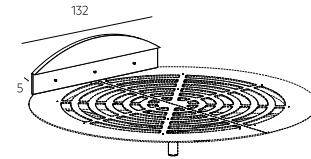

AIR_BED



Pianale rete con telaio
Platform with frame

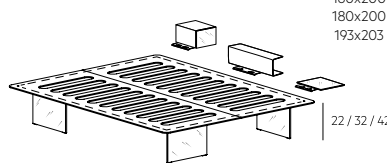

Materasso
Mattress
(cm)

100x200
120x200
150x200
152x203
160x200
180x200
193x203

Schienali sp. 18,4
Backrests th. 18.4 cm

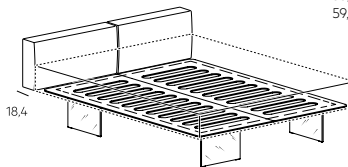

↑	←
(cm)	(cm)
36,8	36,8
41,4	55,2
46,0	59,8
50,6	64,4
55,2	73,6
59,8	78,2
	82,8
	92,0
	110,4
	128,8
	147,2
	184,0
	220,8
	257,6

Testiera Sp. 8cm
Headboard th. 8cm

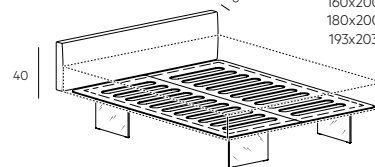

Materasso
Mattress
(cm)

100x200
120x200
150x200
152x203
160x200
180x200
193x203

AIR WILDWOOD_BED



Testiera in Wildwood / Wildwood headboard

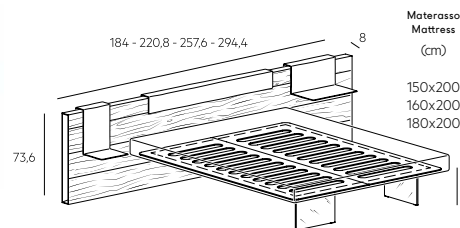

Materasso
Mattress
(cm)

150x200
160x200
180x200

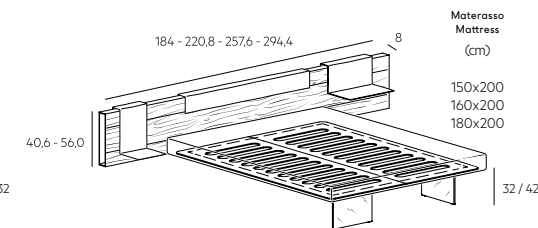

Materasso
Mattress
(cm)

150x200
160x200
180x200

FRAME_BED



Struttura in Wildwood
Wildwood structure

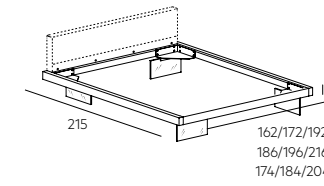

Testiera - Rivestimenti Tessuti Lago
Headboard - Coverings in Lago fabrics

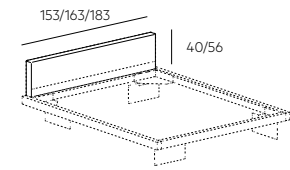

Materasso
Mattress
(cm)

150x200
160x200
180x200

VELE_BED



Testiera - Rivestimenti Tessuti Lago
Headboard - Coverings in Lago fabrics

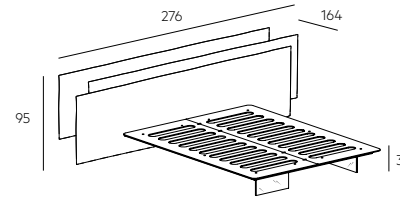

Materasso
Mattress
(cm)

150x200
160x200
180x200

COLLETO_BED



Rivestimento in tessuto stretch.
Covering in stretch fabric.

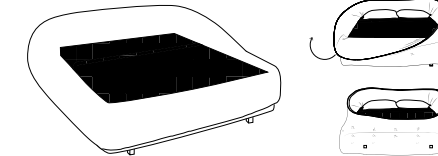

Materasso
Mattress
(cm)

100x200
120x200
152x203
160x200
180x200

LAGOLINEA_BED

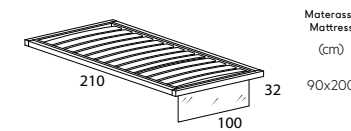

Materasso
Mattress
(cm)

90x200

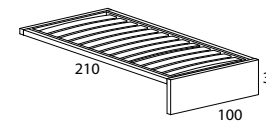

Testiera - laccato o in ecopelle
Headboard - lacquered or in eco-leather

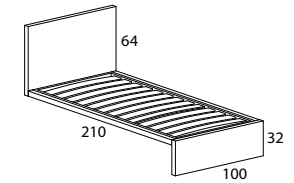

Cuscino - rivestimento tessuti Lago
Pillow - covering in Lago fabrics

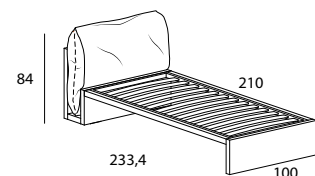

Pannelli imbottiti - rivestimento tessuti Lago
Padded panels - covering in Lago fabrics

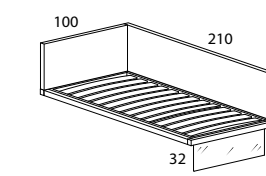

Spondina - tessuto stretch
Bedguard - stretch fabric

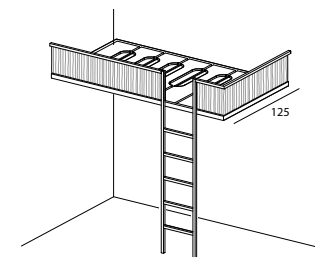

N.O.W._WARDROBE

Armadio battente / Hinged door wardrobe

Anta vetro lucido, vetro opaco, specchio
Polished glass, matt glass, mirror door.

Tipologia di colonne / Column types

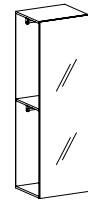
Intera
Single piece

↑ (cm)	↔ (cm)	↗ (cm)
227,0	43,5	61,0
243,0	47,5	
265,0	68,5	
290,0		

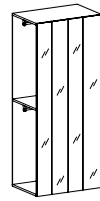
Asimmetrica
Asymmetrical

↑ (cm)	↔ (cm)	↗ (cm)
227,0	43,5	61,0
243,0	47,5	
265,0	68,5	
290,0	89,5	
	97,5	
	99,5	
	112,5	

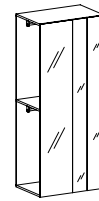
Varia
Others

↑ (cm)	↔ (cm)	↗ (cm)
227,0	68,5	61,0
243,0	89,5	
265,0	97,5	
290,0	99,5	
	112,5	

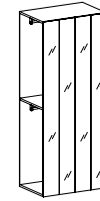
Regolare
By regular steps

↑ (cm)	↔ (cm)	↗ (cm)
227,0	43,5	61,0
243,0	47,5	
265,0	89,5	
290,0	97,5	

N.O.W. SMART_WARDROBE

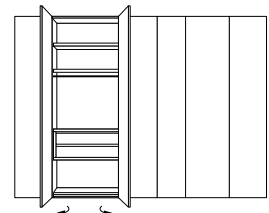
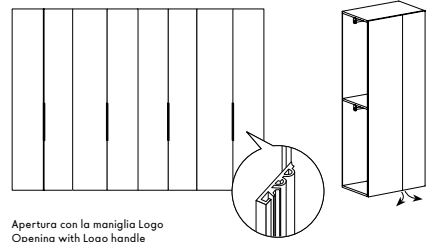
Anta laccata
Lacquered doorApertura push-pull
Push-pull openingApertura con la maniglia Logo
Opening with Logo handle

↑ (cm)	↔ (cm)	↗ (cm)
227,0	43,5	61,0
243,0	47,5	
265,0	68,5	
290,0	89,5	
	97,5	
	99,5	
	112,5	

N.O.W. SLIDING

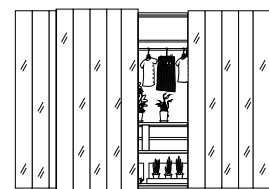
Anta vetro lucido, vetro opaco, specchio
Polished glass, matt glass, mirror doorArmadio scorrevole
Sliding door wardrobe

Tipologia di colonne / Column types

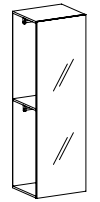
Intera
Single piece

↑ (cm)	↔ (cm)	↗ (cm)
227,0	68,5	68,0
243,0	89,5	
265,0	97,5	
	99,5	
	112,5	
	139,5	

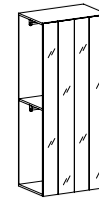
Asimmetrica
Asymmetrical

↑ (cm)	↔ (cm)	↗ (cm)
227,0	68,5	68,0
243,0	89,5	
265,0	97,5	
	99,5	
	112,5	
	139,5	

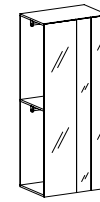
Varia
Others

↑ (cm)	↔ (cm)	↗ (cm)
227,0	68,5	68,0
243,0	89,5	
265,0	97,5	
	99,5	
	112,5	
	139,5	

DUÉE_WARDROBE

Anta vetro lucido o laccata
Polished glass or lacquered door

↑ (cm)	↔ (cm)	↗ (cm)
243,0	68,5	68,0
265,0	89,5	
	97,5	
	112,5	
	120,5	

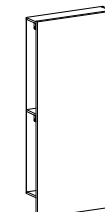
Anta laccata
Lacquered door

↑ (cm)	↔ (cm)	↗ (cm)
243,0	68,5	68,0
265,0	89,5	
	97,5	
	112,5	
	120,5	

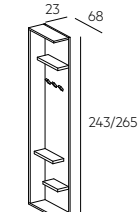

ET VOILÀ_WARDROBE

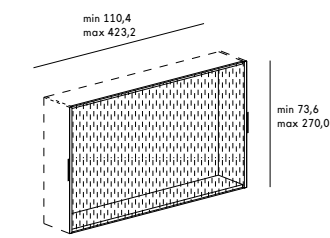
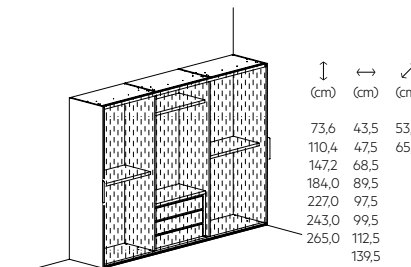
Frontale in tessuto
Fabric frontStruttura a vani a terra
Floor compartment structure

↑ (cm)	↔ (cm)	↗ (cm)
73,6	43,5	53,0
110,4	47,5	65,4
147,2	68,5	
184,0	89,5	
227,0	97,5	
243,0	99,5	
265,0	112,5	
	139,5	

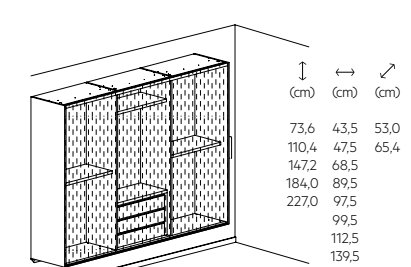
Struttura a vani sospesi
Wall-mounted compartment structure

↑ (cm)	↔ (cm)	↗ (cm)
73,6	43,5	53,0
110,4	47,5	65,4
147,2	68,5	
184,0	89,5	
227,0	97,5	
	99,5	
	112,5	
	139,5	

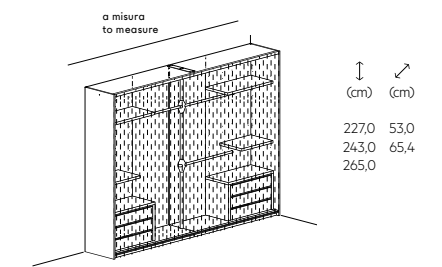
Struttura ad albero - Et Voilà Tree
Tree structure - Et Voilà Tree

↑ (cm)	↗ (cm)
227,0	53,0
243,0	65,4
265,0	

36E8®_BASIN

Top vetro lucido con vasca termoformata integrata, laccato colori Lago. Utilizzabile solo su basi.
Polished glass top with built-in thermoformed basin, lacquered Lago colours. It can only be used with base units.

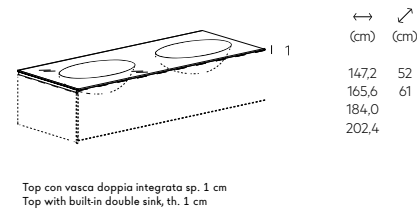
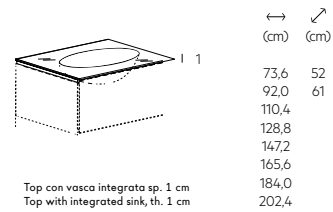

DEPTH_BASIN

Lavabo con fondo vasca in vetro trasparente temperato, in laminato HPL, Wildwood or resina.
Sink with basin in clear tempered glass, laminate HPL, Wildwood or resin.

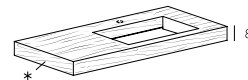
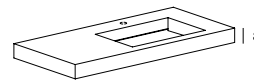
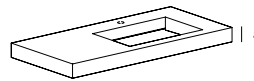
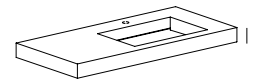

Wildwood

Resina
ResinLaminato monocolore
Monocolour laminateLaminato Mood
Mood laminate

Vasca singola Single basin		Vasca doppia Double basin	
↕ (cm)	↔ (cm)	↕ (cm)	↔ (cm)
73,6	52,0	147,2	52,0
92,0		184,0	
110,4		220,8	
147,2			
184,0			
220,8			

CELLULE_BASIN

Lavabo freestanding in CRISTALPLANT® bianco abbinabile al colore puro touch Lago o laccato esternamente nei colori Lago.
Accessori posizionabili a piacere, una volta fissati non ruotano.

Freestanding sink in white CRISTALPLANT® which can be combined with Lago puro touch or lacquered externally in Lago colours. Accessories can be positioned as desired. Once secured they do not rotate.



CRISTALPLANT® bianco
White CRISTALPLANT®
Laccatura esterna opzionale
Optional external lacquer

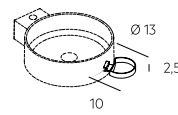
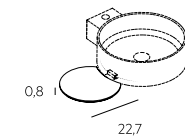
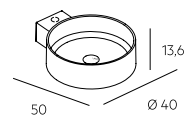

LAGOLINEA_BASIN



Lavabo in CRISTALPLANT® bianco abbinabile al colore Puro touch Lago.
Sink in white CRISTALPLANT®, it can be matched with Puro touch Lago colour.

LAGOLINEA - senza raccordi
LAGOLINEA - without fittings

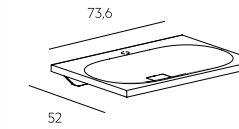

LAGOLINEA - 1 raccordo
LAGOLINEA - 1 fitting

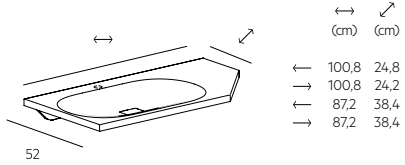

LAGOLINEA - 2 raccordi
LAGOLINEA - 2 fittings

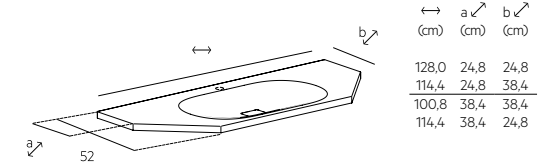

SKIN_BASIN

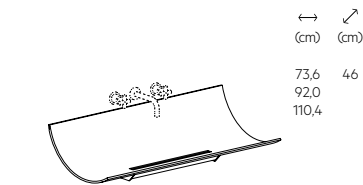
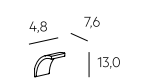

Lavabo e accessori in acciaio inox AISI 304 finitura satinata, rivestibili in mosaico 2x2 o resina.
Sink and accessories in AISI 304 stainless steel satin finish, to be covered with mosaic 2x2 or resin.

Mensola
ShelfPortasciugamani
Towel Bar

INBILICO_BASIN



Lavabo in appoggio in ceramica bianco lucido, utilizzabile su basi o mensole / Supported sink in white polished ceramic, usable with base units or shelves

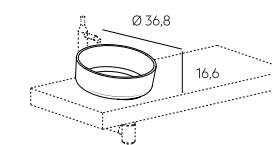

BASICA_BASIN



Lavabo in ceramica bianco lucido. Utilizzabile freestanding o in appoggio su base o mensola / Sink in white polished ceramic. It can be used freestanding or supported on base unit or shelf

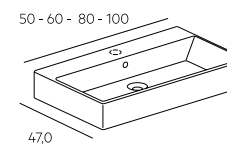

LACCATO, VETRO LUCIDO E VETRO OPACO - Lacquered, polished glass and matt glass



WILDWOOD



MOOD MADETERRANEO - MadeTerraneo moods



ACCIAIO STEEL+ - Steel+ steel



LAMINGLASS



LAMINATO - Laminate

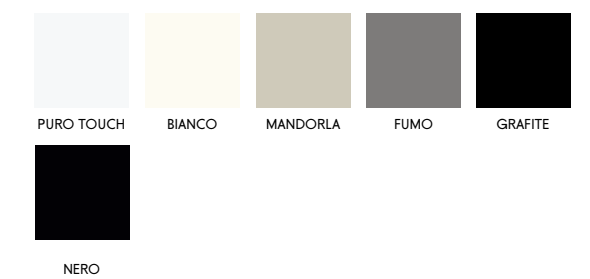

QUARZO - Quartz

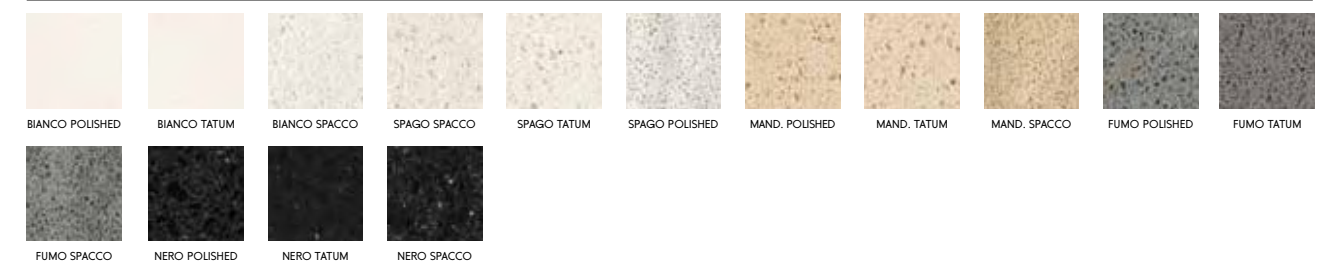

COTONE ECOLOGICO - Organic cotton

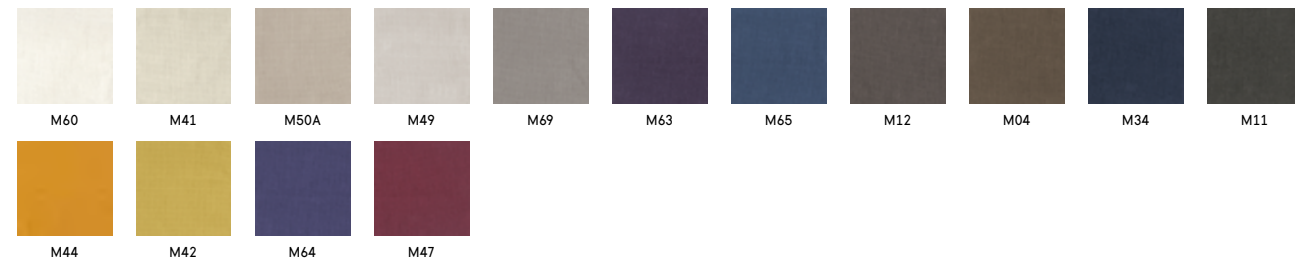

COTONE NATURALE - Natural cotton

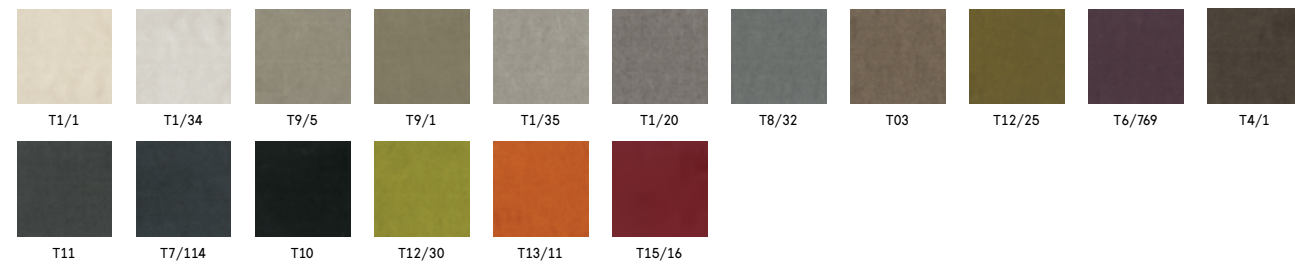

LINO CANOVACCIO - Canovaccio linen

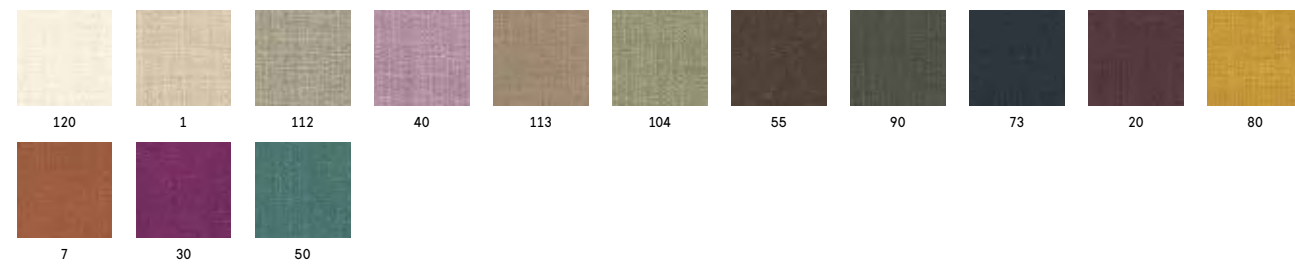

RICO



CAPRI

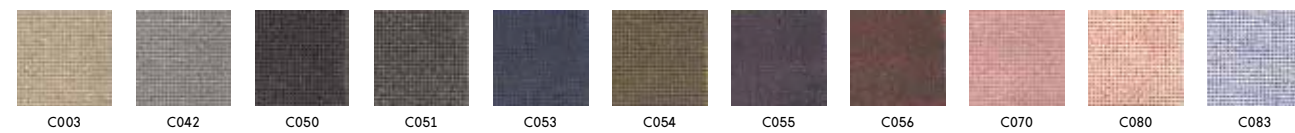

SUN (OUTDOOR)

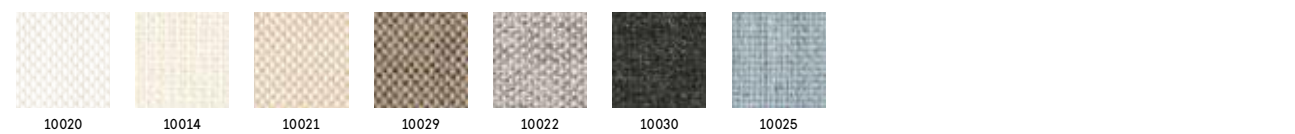

FRANCIS

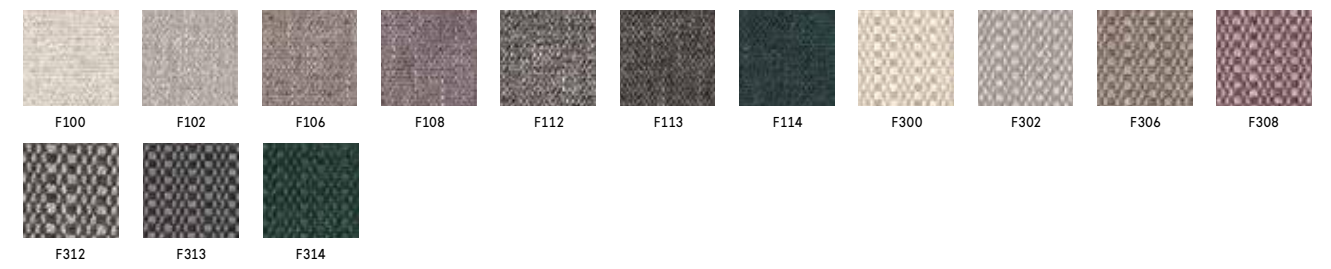

REMIX

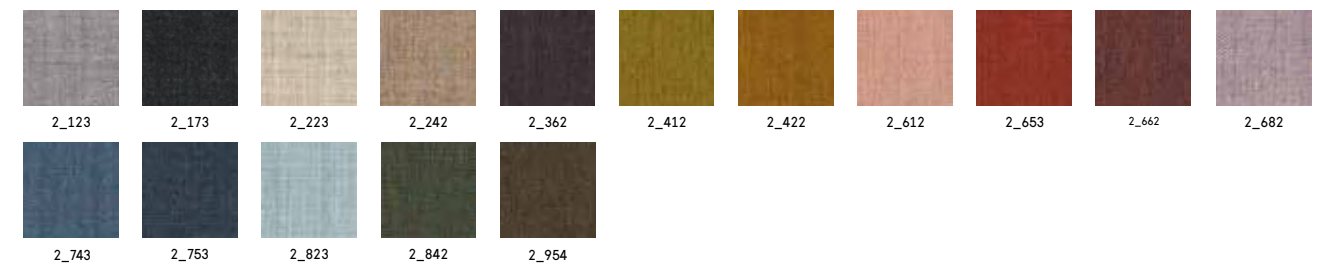

ECOPELLE - Eco-leather

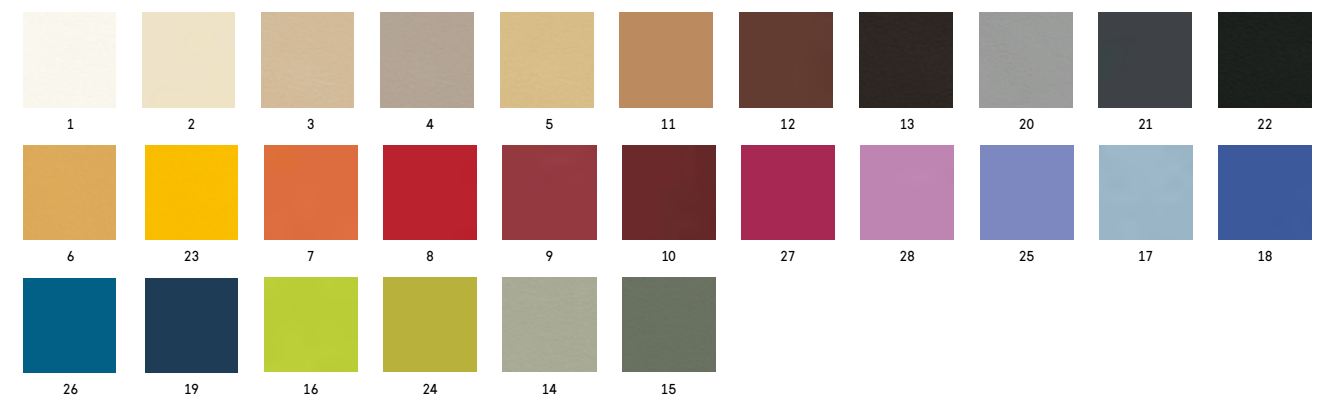

PELLE - Leather



LAGO TAILORING

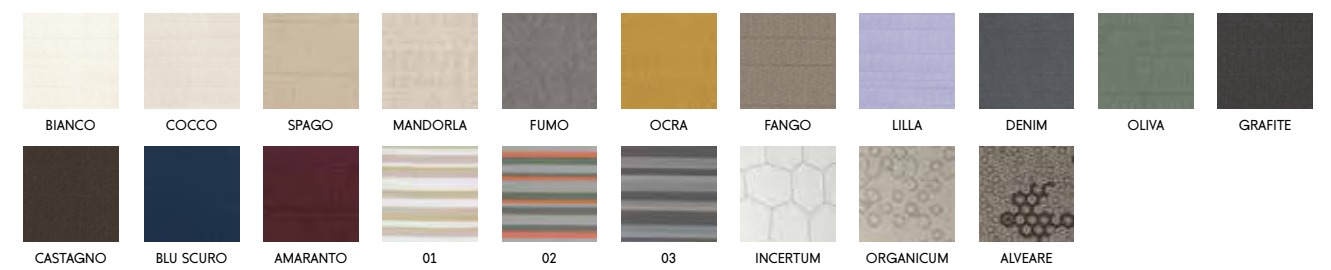

TESSUTO PATCHWORK - Patchwork fabric



PATCHWORK

TESSUTO RIGHE - Striped fabric



STRIPED

TESSUTO STRETCH - Stretch fabric



307

NASTRI ELASTICI - Elastic bands



025

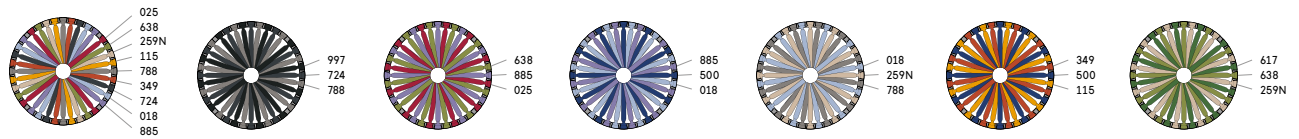

METALLO - Metal



BIANCO RAL 9010

GRAFITE RAL 7024

NERO RAL 9005

CROMO NERO

FELTRO / Felt



GREY

BLACK

ROVERE LACCATO - Lacquered Oak



BAINCO

MANDORLA

AMARANTO

GRAFFITE

NERO

OTTANIO

ROVERE GENTILE - Gentle Oak



NATURALE

GRIGIO

SCURO

FLAT - TAPPETO / Rug

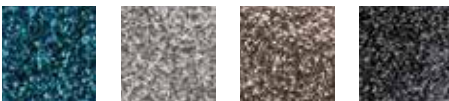

F180

F940

F670

F990



F610

F630

F230

F890

CURLY - TAPPETO / Rug

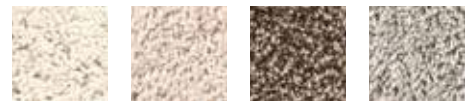

G600

G640

C780

G920



G940

With LAGO, you can design interior solutions tailored
for you, your home, your dreams.

LIVING ROOM
DINING ROOM
KITCHEN
BEDROOM
KIDS&YOUNG
BATHROOM
WORKSPACES

LAGO.IT